



2025 Snipe Class

Measurement Handbook





SCIRA

Snipe Class International Racing Association

2812 Canon Street - San Diego, CA 92106 USA

jerelyn@odmsail.com

snipe.org

Cover: Antonio Espada measuring at 2015 Worlds in Talamone, Italy

Back: measurements at 2024 Worlds in Buenos Aires, Argentina

Photos: Matias Capizzano

This Handbook is updated to:

the 2025 Snipe Class Rules

the 2025 Snipe Constitution, Bylaws and RoC

the 2025-2028 WS Racing Rules of Sailing and WS Equipment Rules of Sailing

the 2017 WS Measurers' Manual

WHAT'S NEW IN THIS EDITION

Page 29	added keel width measurement instructions
Page 40-41	added instructions on mast and boom measurements
Page 42	added explanations on rudder measurement
Page 43-44	added explaining photos and drawings on daggerboard measurement
Page 46	added explaining photos on allowed carbon
Page 47	added information on shrouds adjusters, jib tack fitting and hull number
Page 50-51	added explaining photos on mainsail measurement and identification
Page 54	added explaining photos on jib measurement
Page 57	added instructions on mast weighing
Page 59	updated Technical Committee duties at events according to RRS 2025-2028
Pages 62 to 65	updated Equipment Inspection Sheets and Regulations

New rules are in italic underlined

Introduction

SCIRA has been in existence for over 90 years with about 32,000 boats built around the world. Shortly after the proliferation of the Class, a need for measurement to ensure consistency and to maintain the one-design nature was necessary.

Original boats were made of wood and the current tolerances exist to accommodate those who still prefer to build Snipes of plywood. Once fiberglass Snipes were introduced, the measurement process became more standard with molds. However, modernization and the evolution of the Snipe over its 90+ years have requested standardization of the measurement process.

This handbook is to assist each country to ensure proper measurement techniques and apply consistency of measurement around the world for Snipes.

Remember that Snipe measurements shall be conducted according to this handbook, the Snipe Class Rules, the World Sailing Equipment Rules of Sailing and the World Sailing Measurer's Manual, other than the Racing Rules of Sailing where applicable.

The purpose of the SCIRA Measurement Handbook and the intent of the Technical Committee are to standardize Snipe measurement worldwide. A clear explanation of the preferred method will ensure as much as possible that all measurers will follow and apply the rules in the same way in all countries.

To reach this goal, SCIRA International selected, produced and distributed a set of approved tools to all National Secretaries and builders. An updated, standard measurement frame was also created to more consistently measure the Snipe. More tools are now being studied to make measurement easier.

Springs for the MOI test are distributed exclusively by the SCIRA Office accompanied by the constant figures necessary to determine the minimum time to reach the 271 kg*sq.m which is now the standard value after the adoption of the SI standards.

The combined use of the above mentioned tools, the compliance with the World Sailing's Equipment Rules of Sailing and the Measurers' Manual allow measurers to inspect the boats in a standard, fair and efficient way.

Also introduced, and now enforced after the approval of the new Class Rules, written according to the World Sailing standard for the recognized International Classes, were the measurement stickers that at completion of measurement are applied on measured equipment. This system saves time and reduces controls at all events for both the measurers and sailors alike.

SCIRA also continues to hold measurement clinics either on site or online to educate current and new measurers on the latest measurement process.

The intent of the Technical Committee with the support of the Board of Governors is to continue to have coordinated Snipe measurements worldwide.

Antonio Bari - editor
Technical Committee Chairman 2025-2028

Acknowledgements

Thanks to all those who tirelessly helped put this handbook together;

Text: Antonio Bari, Giorgio Brezich, Steve Stewart, Jerelyn Biehl, Gus Wirth

Photography: Phillip Magura, Antonio Bari, Giorgio Brezich, Aoi Funaki, Andrea Francesca Dell'Ora, Matias Capizzano, Stefano Longhi, Enrico Michel, WS Measurers' Manual

Drawings: Antonio Bari, Matt Anderson, WS Equipment Rules of Sailing and to Luis Gonzales Alvarez for his competent contribution

International Technical Committee

Technical Committee

The Board of Governors shall appoint a Technical Committee consisting of the Chairman of the Technical Committee, Vice Chairman, Chief Measurer, 4 Technical Committee members and the Chief Information Officer. The four appointed members and the CIO shall not be elected members of the Board of Governors. The Technical Committee in accordance with World Sailing Regulations shall maintain, study and make recommendations on all Class Rules restrictions, including but not restricted to the Rules of Conduct, Deed of Gifts, Constitution and Bylaws. This Committee, in accordance with World Sailing Regulations, shall have power to clarify any rule whenever its meaning is deemed not clear or unfair. If necessary, such clarifications may be submitted as rules amendments to World Sailing after approval of the Board of Governors.

Whenever a "circular Letter" from the Technical Committee over the signature of the Chairman is posted on the Snipe website the corrections, interpretations or simplifications appearing therein shall become a part of the current rules. Such corrections, interpretations or simplifications will also be posted on the SCIRA website, Rules section. www.snipe.org

Chief Measurer

The Board of Governors shall appoint a Chief Measurer. He shall serve a four-year term taking office in even numbered years, with re-election possible after the first term. He shall be responsible for managing the Class Measurers worldwide. He shall be a member of the Technical Committee and shall advise that Committee on Measuring Rules problems. The Chief Measurer shall supervise all certified measurers, grant or reject measurement certificates, and answer questions on measurement rules in coordination with the Chairman of the Technical Committee. Subject to the approval of the Technical Committee, he shall establish and maintain measurement standards, forms and techniques. He may recommend to the Board changes in plans and specifications.

Chief Information Officer

Duties include maintaining web site, Internet requirements and e-mail requirements of the Association. Review of all technology used or to be used by the Association, including but not limited to telephone, computer, hardware, software, measurement and rules. He supports the Technical Committee on technical issues by doing research on new technology for old methods. He supports the Association's Board of Governors on technical issues by explaining details on complex technology issues.

Rules Amendments

Proposed amendments to Constitution, By-Laws and Class Rules shall be submitted to the Executive Director by March 1 and circulated to all members of the Technical Committee for comments and recommendations as well as publication of the proposal, posting on the Snipe website and via email to all National Secretaries with discussion held from March to June. The Technical Committee will then discuss, vote and make recommendations to the Board for consideration of a vote by the Board of Governors July 1-10. Each proposed rule change must appear on at least two agendas, with amendments offer able on the first circulation, and a vote on the amendments on the second or final vote on the change if no amendments were offered. Consideration at a properly called meeting of the Board may count as the second or third agenda appearance. An absolute majority of the Board is required for final passage. If approved, the proposed Class Rules will be submitted to WS for approval and if approved, will be published to the members by December 1 with application January 1st. Class Rules changes may take effect only on January 1st of each leap year (2020, 2024, 2028, etc.). Changes can be made at times other than the specified four-year intervals where the Board considers them to be of extreme urgency. Constitution and By Laws changes will take effect on January 1st of the following year. Changes to the Deeds of Gift and the Rules of Conduct shall be approved by the Board of Governors at any time to be effective on January 1st of the following year.

The members of the Technical Committee are available at

<https://www.snipe.org/board-officers/>



Measurer Requirements & Responsibilities

The basis of the measurement process begins with the National Secretary organizing the various levels of measurers.

The National Secretary

- Keeps a list of current measurers in the country;
- Assigns SCIRA stamps to appropriate measurers sending corresponding list to SCIRA Chief Measurer with copy to SCIRA Office;
- Issues Measurement Certificates to owners based upon recommendation from the National or International Measurer;
- Appoints, after appropriate training period, the Measurers according to the following requirements:

Fleet: is the measurer of the fleet elected by fleet members (see Constitution, section 9) entitled to measure sails, spars, weight, verify decals and stickers and generally overview the boats compliance to rules (mast partner location, daggerboard retaining system and stripe, mast step compliance, rudder security system). The fleet measurer should re-weigh the fleet boats at start of each season.

Responsibilities

- Hold annual weighing session and possible measurement update for fleet members
- Notify the National Secretary any changes in the Measurement Certificate
- Attend measurement clinics when possible

National: is a more experienced measurer, appointed by the National Secretary after a training period as fleet measurer and after participating in a national measurer's clinic called by the National Secretary, or to an international clinic. He is entitled to measure the boats at events of a national level, and cooperate with international measurers at international events. National measurers are entitled to fully measure and check boats and equipment and use the SCIRA stickers to permanently identify the hull and other items already checked and found conform to rules. A National Measurer is entitled to become a Certified Builder measurer.

Responsibilities

- Organize measurement clinics for national measurers
- Oversee measurement at National championship and at major championships held in your country
- Report measurement inconsistencies to Chief Measurer
- Propose recommendations for measurement rules to Chief Measurer or Technical Committee
- Attend international measurement clinic

International: is one of restricted and most experienced measurers, identified by the International Chief Measurer and appointed by the Technical Committee, who have attended an International Measurer's clinic. An International Measurer is entitled to assist the professional builders, measure their plugs, moulds and the production as per Builders Certification, *section 3*. He is also entitled to appoint National Measurers to serve as builders' measurers as per Builders Certification, *section 5*. The International Measurers will report their comments on rules application to the Chief Measurer.



Objectives of the Snipe Class Rules

Snipe hulls, hull appendages, rigs and sails are measurement controlled. Equipment is required to comply with the International Snipe Building Specification.

Measurement procedures and tools are explained in the Measurers' Handbook furnished by SCIRA. Snipe hulls, hull appendages, rigs and sails may, after having left the manufacturer, only be altered to the extent permitted in Section C of the Class Rules.

Rules regulating the use of equipment during a race are contained in Section C of the Class Rules, in Equipment Rules of Sailing (ERS) Part I and in the Racing Rules of Sailing. Owners and crews should be aware that compliance with rules in Section C is not checked as part of the certification process.

**THE RULES ARE CLOSED CLASS RULES WHERE
IF IT DOES NOT SPECIFICALLY SAY THAT YOU MAY – THEN YOU SHALL NOT.**

Hull Certification

A.12 INITIAL HULL CERTIFICATION

A.12.1 For a certificate to be issued to a hull not previously certified:

- (a) Equipment certification measurement shall be carried out by an official measurer who shall complete the Measurement Data Sheet (MDS) provided by SCIRA.
- (b) The MDS and certification fee, if required, shall be paid to the Measurer.
- (c) Upon receipt of a satisfactorily completed MDS, the Certification Authority may issue a certificate.

A.13 VALIDITY OF CERTIFICATE

A.13.1 A hull certificate becomes invalid upon:

- (a) The change to any items recorded on the hull certificate as required under A.11 or the MDS.
- (b) Withdrawal by SCIRA or NCA,
- (c) The issue of a new certificate.

A.13.2 Hulls built before January 1st 1976 that have not been modified in their shape or materials need not be recertified.

A.14 HULL RE-CERTIFICATION

A.14.1 The Certification Authority may issue a new certificate to a previously certified hull:

- (a) When the certificate becomes invalid under A.13.1(a) after receipt of the old certificate and certification fee, if required,
- (b) When it is invalidated under A.13.1 (b), at its discretion.
- (c) In other cases, by application of the procedure in A.12.

Special procedures in measurement

For measurement for certification, the measurer must refer to the class rules current at the time of measurement. However, hull re-measurement and measurement of repairs rebuilds are normally to be made in accordance with the class rules that were in effect when the boat was first measured for certification. This is often known as the "grandfather clause" and may necessitate researching to find out what the rules were some years in the past. If in doubt, contact the SCIRA office.

Amendments to Class Rules

The Technical Committee is constantly trying to update and improve the Snipe Class Rules. Any amendment or change to the Class Rules after the approval of the Board of Governors is subject to the approval of World Sailing in accordance with WS Regulations. Any change in the Class Rules is published on the SCIRA website.

Interpreting or clarifying Class Rules

There will be occasions when the meaning of a class rule is not clear to the measurer. When measuring for certification the measurer should contact the Chief Measurer or the Technical Committee Chairman for clarification before signing the Measurement Data Sheet (MDS) and describe on the MDS what he has found, so the SCIRA office can alert the Chief Measurer to determine whether a measurement certificate is to be issued or not.

All rules interpretations are made in accordance with the World Sailing Regulations. Decisions of the Technical Committee are published on the SCIRA website.

The Class Rules are published on the SCIRA website: <https://www.snipe.org/rules/class-rules> and on <https://www.sailing.org/classes/snipe/#Documents>

According to the Constitution, Section 30, Class Rules changes may take effect only on January 1st of each leap year (2020, 2024, 2028, etc.). Changes can be made at times other than the specified four-year intervals where the Board considers them to be of extreme urgency.

Effective date: 2025-01-01
Status: Approved



Class Rules

Snipe Class International Racing Association



The Snipe was designed in 1931 by William F. Crosby and was adopted as a World Sailing class in 1932. Photo taken by Matias Capizzano

sport / nature / technology



The Measurement Process

- boat produced
- measured by certified measurer
- installation of measurement stickers on boats (by a National Measurer only)
- Measurement Data Sheet completed: original sent to SCIRA office, copy to National Secretary with measurer's stamp
- Measurement Certificate given to owner

How to Measure a Snipe will be included in another section of this handbook, with details, photos, etc. of measuring a Snipe.

Extract from SCIRA By-laws

Section 5. Measurement

Each boat, to be eligible to race, must hold a Measurement Certificate recommended by the Measurer and approved by the Technical Committee of the Association. To obtain such a Certificate the boat must be examined by the Measurer who shall report his findings on a Snipe Class Measurement Data Sheet (MDS) currently approved by the Technical Committee. If the boat complies in all respects the Measurer shall fill out a the Measurement Data Sheet (MDS) and send one copy of the same to the National Secretary with the owner's current dues and the original to SCIRA Office. The owner then becomes a member of the Association and will receive the Measurement Certificate from his/her National Secretary.

Section 6. Measurer's Duties

It shall be the duty of a Measurer to call to the attention of the Association any and all discrepancies not found to be within the tolerances shown on the current Measurement Data Sheets. Any discrepancy found on a professionally built boat shall be corrected before a certificate is issued. In case there are discrepancies on a home built boat, and if (in his opinion) the discrepancies are of minor importance of the boats sailing qualities, the Measurer may give a Limited Measurement Certificate good only for Club or Fleet races provided such discrepancies are clearly indicated on the Data Sheet. However, final decision shall rest with the Chief Measurer. Boats holding a Limited Measurement Certificate shall not race in any Sanctioned regatta or Major Championship.

When the Fleet Measurer is the owner of a Snipe, he should be the chairman of a committee for measuring boats and recommending issuance of Measurement Certificates. No person may take or record the measurements of a Snipe in which he is financially or otherwise interested. The Association may refuse to accept further recommendations for Measurement Certificates from any Measurer or committee that is found guilty of negligence or misrepresentation regarding measurement.

Section 7. Measurement Fee

Measurement fees are fixed by the Fleet or by the Measurer with the approval of the Fleet. Of this fee the amount specified for each country shall go to the National Secretary, together with Measurement Data Sheet, which sum will be considered as the owners' dues for the ensuing year.

Section 8. Measuring Unattached Boats

Boats may be owned in localities where no fleet is in existence. The owners of such boats may, upon application to the National Secretary, receive a Measurement Data Sheet to be filled in relative to the boat, appendages and rig. Upon returning this to the National Secretary, together with Class dues, a Provisional measurement Certificate will be issued provided the boat appendages and rig are found to be within the limits of the Class. This Provisional Measurement Certificate shall be subject to ratification by an accredited Measurer who shall re-measure the boat and who shall be empowered to recommend a full Certificate of Measurement. Provisional Measurement Certificates will not permit a boat to take part in any qualifying regatta or major Championship.

Measurer's Supplies

Tools Needed for Measurement

- SCIRA provided measurement tools (see handbook)
- Pencils
- Permanent markers
 - thin tip
 - fat permanent marker for limiting marks
 - permanent paint pen for use with measurement stickers
- Tape Measurer
- Level
- High quality adjustable square
- Calibrated Weight scales:
 - fish or luggage scale for weighing rudder & mast
 - large scale for hull

Items Available from the SCIRA Office for Measurers:

	Fleet Measurer	National Measurer	National Secretary	International Measurer
Rulebook	√	√	√	√
Measurement Stickers/pen		√		√
Measurement Certificates-blank			√	√
Measurement Data Sheet-blank		√		√
Measurer's Stamp			√	√

The following items can be requested through the SCIRA office by the National Secretary:

- Measurement "void" stickers: specify
 - Small: equipment
 - Large: hull
- Moment of Inertia springs \$ 75.00
- Sail Royalty labels \$ 25.00
- New hull numbers \$100.00

The Measurement Procedures

- boat produced
- measured by certified measurer (National or International Measurer only)
- installation of measurement stickers on boats
- Measurement Data Sheet completed: original sent to SCIRA office, copy sent to National Secretary
- Measurement Certificate given to owner

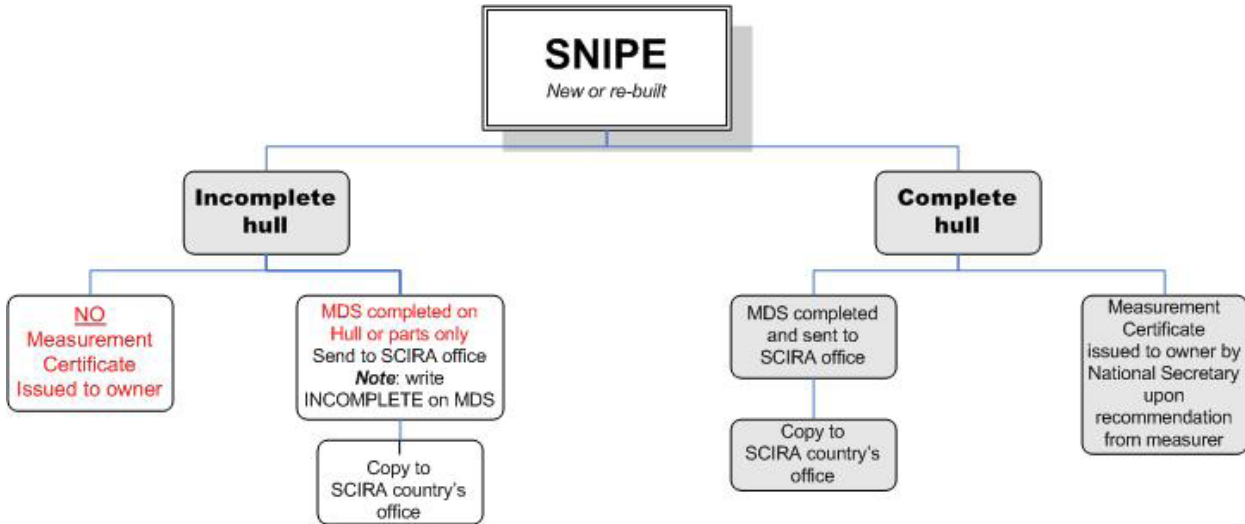

Measurement Data Sheet (MDS)

The Measurement Data Sheet (MDS) is the official measurement form completed on all boats built. The MDS is the permanent record for a boat. If a boat is sold and perhaps moved to a new country, the MDS remains in the SCIRA office for reference. These forms have been modified over the years and are referred to alphabetically as “sheet A” etc. based upon the year the boat was built. Newer versions are based upon rules changes passed by the Board of Governors. The MDS consist of two parts.

Part 1 records all the measurements of the boat. It is completed if the boat is built from non-certified molds or to renew the Certification according to the Builders’ Certification Rule.

Part 2 records the variable measurements and is completed for all boats. A new boat will be measured under the most current MDS while an older boat, not refurbished, will be measured under the Part 1 of the MDS of the year it was built and Part 2 of the current MDS (or according to the appropriate MDS). Certified builders shall complete a full MDS any ten boats manufactured or once a year (whichever is shorter). See Builder Certification at page 14.

SCIRA MDS Rev. "J-d" - July 2019

SCIRA Measurement Data Sheet
To be used with the 80/20 true baseline measurement frame
For boats built from January 1st, 2018. For older boats use the MDS in force in the year of manufacture

Owner _____ Date _____
Hull _____ Builder _____ Material _____

NEW MOULD: FIRST OR OF 5 CERTIFICATION RENEW Y/N
DO NOT COMPLETE IF FROM A CERTIFIED MOULD

Chine						
Station	Height			Width		
	Starboard	Port	Total	Allowable Range	Actual	Allowable Range
1				838-864		527-540
2				724-749		991-1003
3				673-699		1232-1245
4				680-705		1270-1283
5				762-787		1137-1149
Transom				902-927		952-965

Sheer						
Station	Height			Width		
	Starboard	Port	Total	Allowable Range	Actual	Allowable Range
1				1499-1549		895-921
2				1391-1441		1346-1372
3				1333-1384		1511-1537
4				1321-1372		1473-1499
5				1321-1372		1270-1295
Transom				1384-1435		1022-1048

Snipe Class International Racing Association

How to Complete a MDS

The measurer is asked to check to ensure the boat being measured is a legal Snipe. Therefore, all areas must be checked and individual numbers circled to ensure accuracy. If an area does not comply with the rules, then a note must be made on the MDS. All information must be completed. A certified measurer must sign and date the last page if the boat has passed measurement. Use the SCIRA stamp to complete the application.

If a boat does not pass measurement, any irregularities must be noted on the MDS and the form should not be signed. Forward the MDS to the SCIRA office for filing.

Bare Hull or Partial Measurement

If you are asked to measure a hull that is being delivered without equipment or partial equipment, measure the hull to ensure that it is a Snipe. Make a notation on the last page for missing equipment such as:

- Bare hull only
- Mast, boom missing
- Appendage missing, etc.

Where to Send

When the MDS is completed or completed as much as possible, the original MDS shall be mailed to the SCIRA office for permanent keeping and a copy to the National Secretary. A copy may be kept with the measurer for safekeeping.

SCIRA MDS Rev. "J-d" - July 2019

Keel				Stem Offset			
Station	Height		Width		up from baseline	back from HDP	Actual
	Actual	Allowable Range	Actual	Allowable Range	267	267-279	
400mm		223-235			305	194-206	
1		162		Min 51	337	153-165	
2		89-101		99-105	381	108-120	
3		51-63		99-105	457	54-66	
4		58-70		99-105	527	36-38	
5		114		99-105	311 to 387	intersection of chine extension	
Transom		166-178		99-105			

Miscellaneous					
Measurement	Actual	Allowable Range	Measurement	Actual	Allowable Range
LOA		4711-4737	Chine radius at st. 1		Max 19
Horizontal transom offset		203-229	Chine radius st. 2 to transom		Max 3
Hull Datum Point height		683-708	Deck height		Max 127
Bow radius		Max 25	Cockpit width		Max 1016

Topside Measurements					
Measurement	Actual	Allowable Range	Measurement	Actual	Allowable Range
Aft end of dagger slot from Hull datum point		2438-2464	Heel point to sheer (vertical)		390-400
Top of case parallel to baseline		tolerance 2	Mast hole in the deck		Max 256x76
Aft edge of slot perpendicular to baseline		tolerance 2	Length of foredeck		Min 1842
Forward edge of slot perpendicular to baseline		tolerance 6	Length of aft deck		Min 457
Keel to top of daggerboard case		310-313	Sheer strikes		Max 32
Length of daggerboard slot		Max 546	Gunwale radius		Max 12
Width of daggerboard slot		Max 13	Splashboard		Min 51 x 610

Measurer _____ Stamp nr. _____

Snipe Class International Racing Association

SCIRA MDS Rev. "J-d" - July 2019

SNIPE CLASS RACING ASSOCIATION
MEASUREMENT DATA SHEET FOR CERTIFIED BOATS
Revised February 2019

This page to be used for all boats. For measurements in *Italic* refer to the Class Rules

HULL NUMBER BUILDER
 MODEL YEAR OF MANUFACTURE
 OWNER COUNTRY

BARE HULL COMPLETE INCOMPLETE
 HULL MATERIAL: WOOD FIBERGLASS make note of incomplete items
 DECK MATERIAL: WOOD FIBERGLASS filling the cells with **NO**

FROM CERTIFIED MOULD

HULL WEIGHT (min 125kg) MAST LENGTH (Rules C.9.2, F.3.4)
 TOTAL WEIGHT (min 172.8kg) Limiting marks & pin
 CORRECTOR WEIGHTS (max 15kg) Corrector weights (max 100gr)
 MOI BOOM LENGTH (max 2642mm)
 Spring set # Limiting marks & pin
 JIB FITTING POLE LENGTH (max 2642mm)

(279-330mm hor. From Hull Datum Point) RIGGER DIMENSIONS
 max 45mm vert. above sheerline) Weight (min. 2.72kg)
 SHROUDS (1778-1981mm from HDP) Corrector weights (Rule C.8.5)
 MAST HOLE (min 1494mm from HDP) Parallel to transom (tolerance 2mm)
 UPPER GUDGEON (Rule D.2.3) DIGGERBOARD DIMENSIONS
 LOWER GUDGEON (Rule D.2.3) Band
 GUDGEONS DIAMETER (Rule D.2.3) Safety line (max 610mm long)
 Restraining system (hooks or tablet)

Insert the **actual** measurement in the cells marked as
 Mark corrector weights position and amount below. Data to be copied on the Official Snipe Label

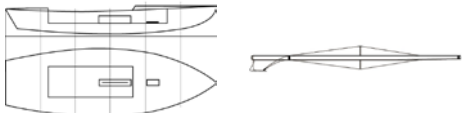

DATE MEASURED _____ MEASURER'S STAMP _____
 MEASURER'S NAME _____
 NOTES: _____

Snipe Class International Racing Association

Measurement Certificate

A Measurement Certificate is a miniature of the MDS that is given to the owner of the Snipe. This is the owner’s proof that the boat is a legal Snipe and presentation of the Measurement Certificate at regattas is mandatory for the registration and measurement processes.

Once a MDS has been completed, the measurer shall send the necessary data to the National Secretary who will issue the Measurement Certificate. The minimum information a MC shall display are:

- (a) Class.
- (b) Number of Measurement Certificate (Optional).
- (c) Hull number issued by SCIRA.
- (d) Builder/Manufacturers details.
- (e) Owner’s name and address.
- (f) Country of registration.
- (g) Total weight of the boat.
- (h) Location and amount of the corrector weights (hull and mast).
- (i) Moment of Inertia.
- (j) Measurer’s name and stamp.
- (k) Date of issue of the initial certificate.
- (l) National Secretary name & stamp.
- (m) Owner’s signature

Lost or Replacement Measurement Certificates

If an owner should loose the Measurement Certificate for his boat, application should be made to the Fleet Measurer or the National Secretary for a new one. The National Secretary will then issue the duplicate. In case the boat is sold to a new owner, the National Secretary shall be informed. Any change in the boat weight, MOI, mast shall be recorded on the MC and the National Secretary informed to keep record of the changes.

Snipe Class International Racing Association
MEASUREMENT CERTIFICATE N. _____

Hull number _____ Year of manufacture _____

Builder _____ Model _____

Weight _____ Corrector weights _____

Mast builder _____ Corrector weights _____

Moi value _____ kg*m²

Owner _____

Country _____

Measurer signature _____

SCIRA stamp# _____ (nation and number)

Date of measurement _____

This certificate is not valid until signed and stamped by the N.S. This certificate indicates that the boat has a registered MDS on file at SCIRA office.

National Secretary stamp and signature _____

Mark corrector weights here

THIS CERTIFICATE REMAINS WITH THE OWNER OF THIS SNIPE.
IT CAN BE REPLACED BY REMEASUREMENT.

I hereby agree to all SCIRA rules and by-laws. I agree to notify a SCIRA measurer if any equipment is modified , replaced and/or transferred to proceed to a new measurement.

SCIRA reserves the right to measure this boat and any equipment at any time.

Owner signature _____

Date _____

CHANGE OF OWNERSHIP

Owner _____ Country _____

Owner signature _____ Date _____

National secretary stamp and signature _____

Owner _____ Country _____

Owner signature _____ Date _____

National Secretary stamp and signature _____

Owner _____ Country _____

Owner signature _____ Date _____

National Secretary stamp and signature _____

Owner _____ Country _____

Owner signature _____ Date _____

National Secretary stamp and signature _____

Measurement Stickers and Labels

Each National Measurer is provided with an inventory of measurement “void” stickers for identification of equipment that has passed measurement. These stickers are marked by the measurer with a permanent paint pen with the hull # and date of measurement. If the sticker is attempted to be removed, it will leave the word “void” on the equipment to prevent the sticker to be placed elsewhere.

The small stickers are to be placed on the following pieces of equipment:

- Mast
- Boom
- Rudder
- Daggerboard
- Whiskerpole



The larger stickers are to be placed in the aft portion of the cockpit with the corrector weights position clearly marked on the hull diagram as well as the hull # and date of measurement. The purpose of this is to give anyone a quick inspection of corrector weights and amount.

The measurement stickers are UV protected, so they should last in the sun and normal sailing conditions.

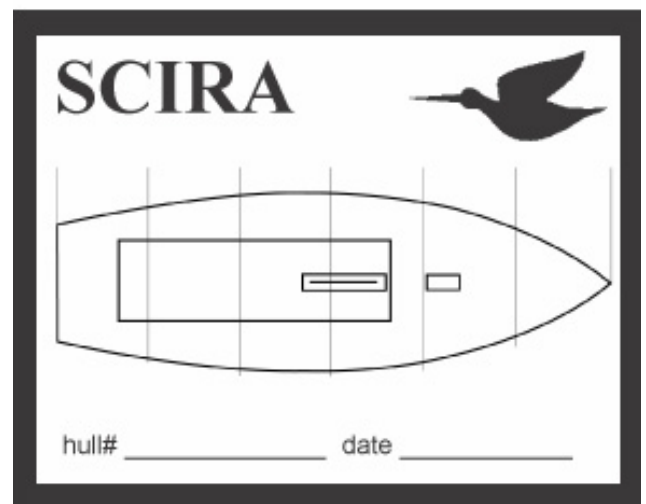

In addition, royalty sails labels shall be applied to every sails before they are measured according to the following Class Rules:

1. A SCIRA sail royalty label shall be permanently attached on any mainsail and jib by the sailmaker. Royalty labels shall be purchased by the builder from SCIRA
2. A stamp shall be imprinted by the sailmaker at the top of the mainsail and jib to certify the weight of the sailcloth

The measurer shall not approve a sail without a royalty label applied. He then will mark the sail on the starboard tack with his signature and SCIRA, MNA or WS stamp.



SCIRA BUILDER CERTIFICATION

A close relationship should exist between builders and sailors for such relationships are among the many strengths of the International Snipe Class. The intent of this Builder Certification Rule is to provide a workable structure for this relationship and to provide a measure of protection for both builders and sailors alike.

To be certified as a Class Builder by the Snipe Class International Racing Association (SCIRA), a builder must agree to and abide by the following requirements.

1. Certification by SCIRA will be required before hull numbers are sold to any new or established builders.
2. To renew the certification, at least one boat of any ten manufactured or one boat per year, whichever is shorter, shall be completely measured by an International Snipe Class measurer or an ISAF measurer.
3. An International Snipe Class Measurer shall measure all new moulds of new builders and the **first boat** manufactured from the mould at the builder's expense. Certification will be given after the first five (5) boats manufactured will be found regular by the Builder's measurer. There will be International Snipe Class measurers selected for Japan (1), For Europe (1), for South America (1), and for North America (1).
4. Any change made on the moulds of an established builder shall be communicated to the SCIRA office and the Chief Measurer and an International Snipe Class Measurer shall measure all new molds of established builders and the first boats manufactured from all new molds of established builders, at the builder's expense.
5. Every certified Class Builder shall select a Builder's Measurer, who shall be satisfactory to the builder's regional International Snipe Class Measurer.
6. The Builder's Measurer shall measure all the fittings, appendages, rig and spars of new boats manufactured by the builder, to include weighing and the Moment of Inertia (MOI) test, at the purchaser's expense. A Measurement Data Sheet (MDS) shall be completed in full by the Builder's Measurer for every new boat manufactured by the builder. The MDS shall then be mailed to the Executive Director of SCIRA, and a Measurement Certificate shall be given to the first purchaser. In the event that an MDS cannot be completed, for whatever reason, the MDS shall be mailed to the Executive Director of SCIRA with an explanation of the reasons why the MDS could not be completed. A copy of the MDS and the explanation shall also be mailed to the builder's regional International Snipe Class Measurer. The purchaser shall only be charged a prorated measurement fee corresponding to the percentage of the MDS that was completed.
7. Every certified Class Builder shall correct manufacturing defects in the boats the builder manufactured, whenever they are found.
8. Any certified Class Builder who repeatedly fails to comply with any of the foregoing requirements, or who breaches the requirements in a material way, shall lose their certification as a Class Builder, after due notice, and may not be re-certified for a period of at least one (1) year.
9. All builders who are actively manufacturing boats as of December 31, 1999 shall be certified by SCIRA as established Class Builders under the foregoing requirements.



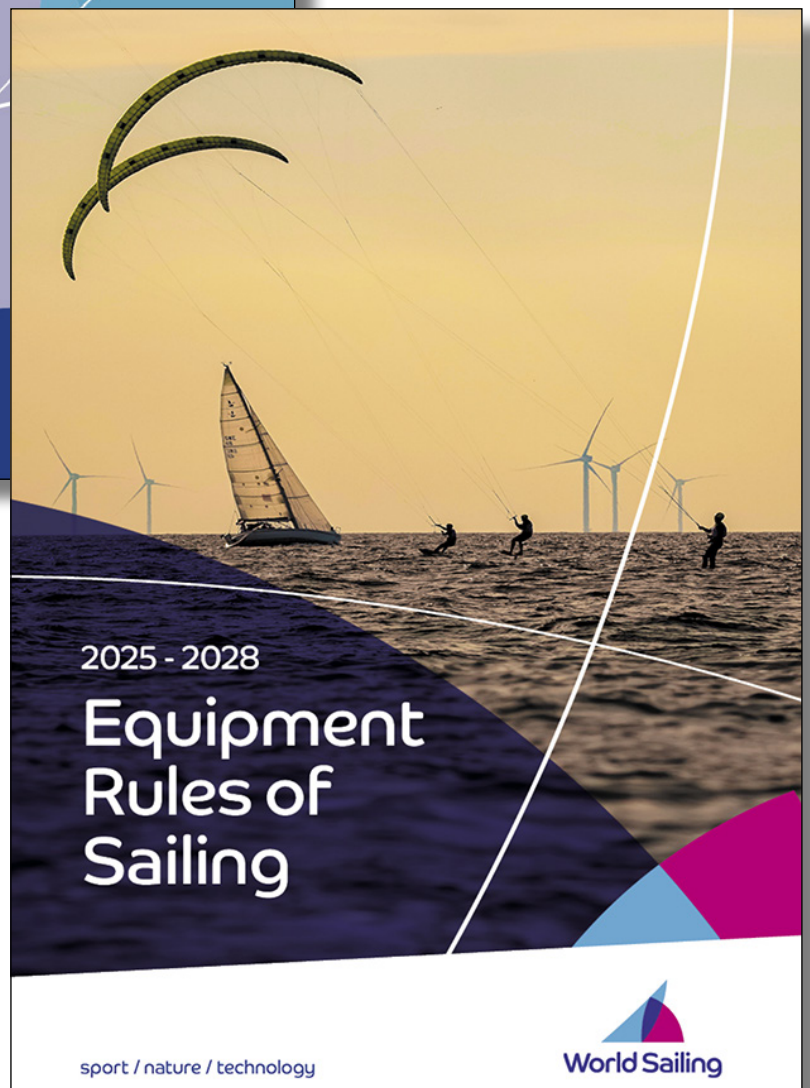
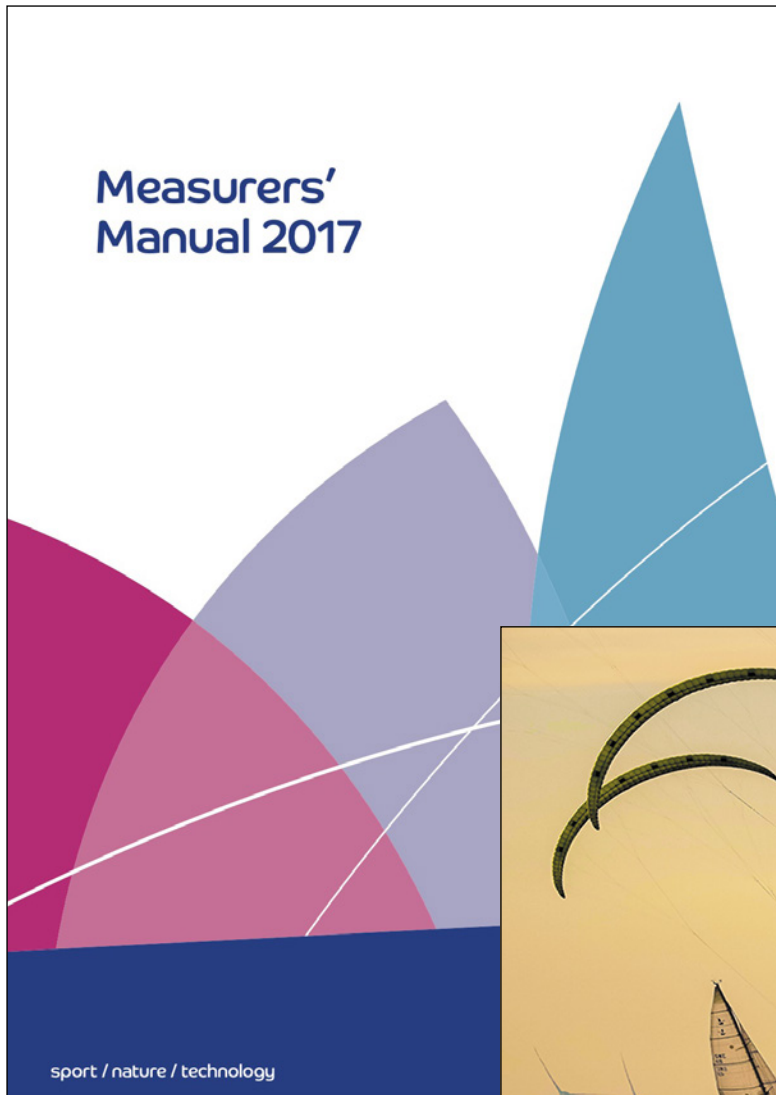

Unless differently specified in the Class Rules, all measurement shall be carried according to the Equipment Rules of Sailing (<https://www.sailing.org/inside-world-sailing/rules-regulations/equipment-rules-of-sailing/>) and the Measurers' Manual ([https://www.sailing.org/tools/documents/IMManual2017-\[21963\].pdf](https://www.sailing.org/tools/documents/IMManual2017-[21963].pdf))

How to Measure a Snipe

The following instructions are to be used to measure new Snipes using the 80/20 sliding arm measuring frame

Snipe measurement frame assembly instructions

The Snipe measurement frame when assembled correctly will provide the measurer with a very accurate tool that is easy to place on the hull and operate. The frame is designed so that it may be easily stored, shipped and assembled. The measurer and an assistant should be able to set up the frame in about 15 minutes if the frame is completely disassembled. The materials and fasteners are all Standard English (US) measurements and dimensions, so it is necessary to have the following tools.

1. Ball end Hex wrenches in 5/32, 3/16 and 1/4
2. A 1/2 open end wrench
3. Three saw horses to support the frame during assembly and storage when it is not in use.

The frame includes the following parts;

PART	DESCRIPTION
01	Front 1/2 main beam
02	Back 1/2 main beam
03	3 barbell connecting lugs
04	center leveling foot
05	Station 1 stabilizing feet with longer rods
06	Station 1 mounting foot
07	Station 5 mounting foot
08	Station 5 stabilizing feet with shorter rods
09	Hull Datum Point fin
10	Cross member
11	Keel height / station locating rod
12	Assembly Tools & Class Rules

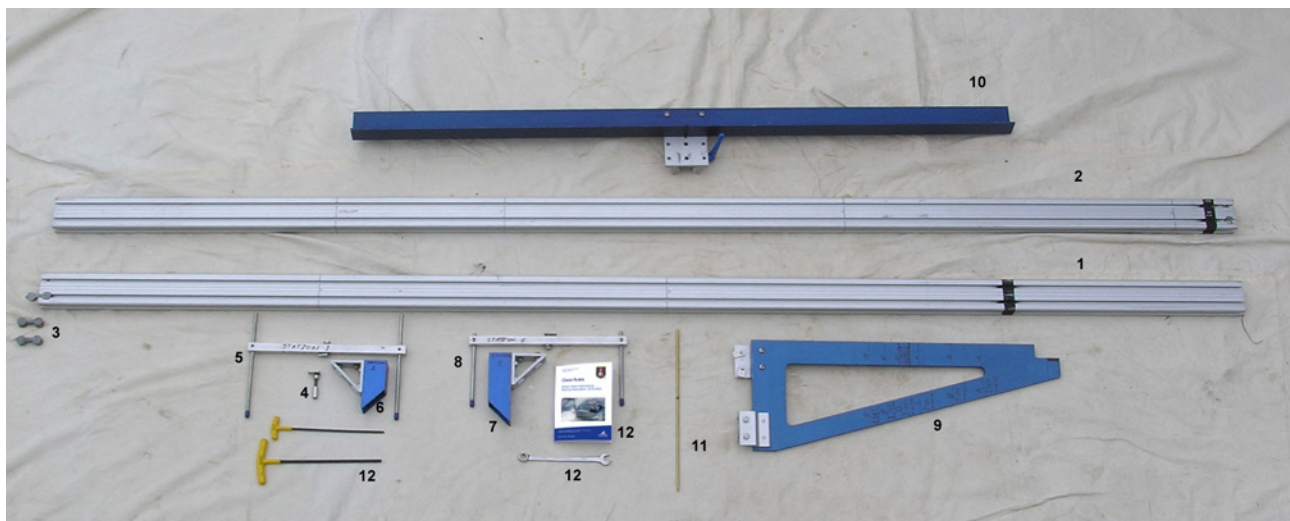

1. Line up the part 1 and 2 main beams so that the connecting lug holes match up to each other and insert the lugs (parts 03) and hand tighten. The use of a saw horse at each end of the frame and a third at the connection point will make assembly easier and save your back. Align the grooves so that they match each other as closely as possible. Now tighten all lugs very snugly. Note: one of the barbell lugs (part 03) has been ground smooth across the top of its face, this lug should be used on the top lug hole so that the cross member (part 10) may slide cleanly across the connecting joint.
2. Slide the leveling foot onto the aft end of the frame and push it forward to just aft of the Dagger board stripe.
3. Slide the stabilizing feet (part 5) onto each end of the frame followed by the station 1(part 06) mounting foot. Position the mount so that the long edge is exactly at the station one line. Tighten the two screws of the mount into the frame. Check to be sure that the foot is still properly positioned. Slide the stabilizer up against the mount and tighten. Make sure that the stabilizer is square to the frame.
4. Repeat step 3 for installing the station 5 mounting foot (part 07) and stabilizer feet (part 08).
5. Slide the hull datum point fin (part 9) onto the frame and hand tighten. Verify that the fin is exactly at the hull datum point mark. Tighten the four screws snugly.
6. Double check stations 0, 1 and 5 to ensure the parts are installed and aligned exactly on their respective stations.
7. You are now ready to flip the frame right side up and slide the cross member onto the frame.
8. Slide the cross member (part 10) onto the frame. Be sure that the blue lock handle is released. Slide the cross member back to station one and insert the keel height locating rod (part 11), now lock the blue handle. The locating rod should slide cleanly through the cross member and frame, this places the cross member exactly on the station.
9. Check to make sure that the cross member is exactly 90° to the frame on the horizontal plane. Make adjustments as needed. Tip; if adjustment is necessary leave the locating rod in place so that there is clean pivot point.
10. Place the frame onto the upside down hull and positioned correctly at the hull datum point. Sight down the frame to note any sag in the middle of the frame. If there is any sag use the center leveling foot (part3) to correct by twisting the barrel so that the sag is removed.
11. Adjust the stabilizer feet (part 5 and 8) so that the frame will not rock side to side.
12. You're finished with assembly. Good luck with your measurements and THANK YOU for volunteering to be a SCIRA Measurer.







The 80/20 frame and related tools when used correctly, will ensure extremely accurate measuring of a Snipe hull. The frame consists of a main beam which carries a sliding car and a cross member. The cross member has a locating point for each of the five stations, these stations are located 787 mm apart at each station. The vertical fin at the front of the frame represents Hull Datum Point (previously station zero). The frame sits on top of the overturned hull at two fixed points and one optional adjustable point. The two fixed points are at stations one and five. These two blocks are pre set so that the lower edge of the frame is at the base line (reference line) of the hull. The third optional point is solely to correct any sag in the Frame.

Remember that all the vertical measurements of chine and sheer to fill in the MDS are to be taken from the upper part of the cross member.

Tools

There are eight additional tools (see photo) needed for use with the frame as follows:

- 1 The locating rod which is used to lock in the five station points, transom points and the point 400 mm aft of the hull datum point.
2. An 1800 mm caliper used to take all beam and width measurements.
3. A straight edge with an adjustable grooved block for locating and measuring sheer heights and locating chine edges.
4. A zero point locator, this important piece is used to find the Hull Datum Point at the stem of the Snipe.
5. the bow radius tool, this bar is used to check for the correct shape of the bow.
6. Two right angle triangles used to measure transom chine, sheer, length and offset.
7. A straight locator tool used to mark various points.
8. A sheer locating tool used to find the sheer points along the deck/ hull intersection.

Other tools you will want to have available are a high quality adjustable square, tape measure and level. It is VERY important to have several sharp pencils to mark the various points on the hull.

The above tools have the proper dimensions and shapes approved by the Technical Committee. All Snipes and equipment shall fit to these tools and NOT tools to the boat.
Official tools shall not be modified.

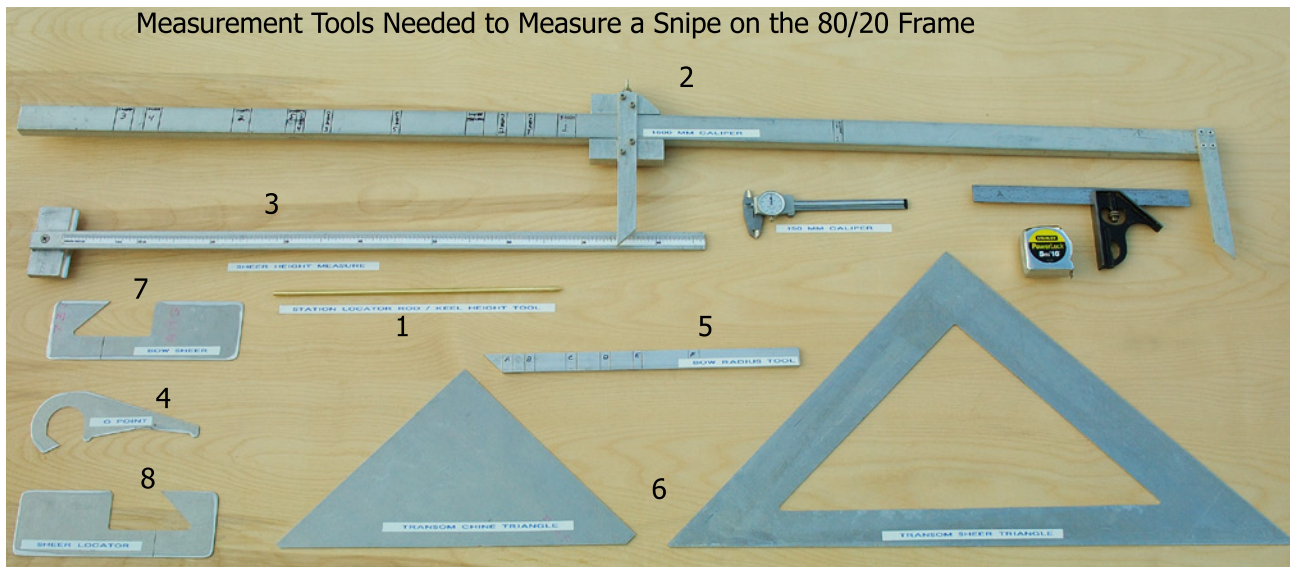

Hull Measurement

This section on hull measurements has been written and photographed for use with the 80/20 measurement frame or any frame where the lower edge of the main beam is the base line.

Hull Datum Point:

Finding the Hull Datum Point is simple: place the tool on the stem edge of the hull so that the point is resting on the top of the deck. It is best to find the Hull Datum Point before the boat is turned upside down. To exactly mark the point use a carbon copy sheet. [See photo](#)



Frame Positioning:

Set the measurement frame carefully onto the keel so that the vertical edge of the fin (this is the zero point of the frame) is exactly on the Hull Datum Point of the hull stem. Use the stem tool to help in aligning the frame remembering that the stem tool must stay in column with the fin to achieve proper positioning. Once the frame is set at zero adjust the leveling feet so that the frame is secured and cannot fall off the hull. Recheck the Hull Datum Point and we are ready to measure the hull.



Stem Height:

With the stem tool check the stem height, it must be within the shaded area on the fin or between 683-708 mm up from the base line. [See photo](#).



Stem Offset Measurements:

Starting at the stem [point A or 527mm up from the base line] measure from the zero point on the measurement frame fin to the bow. The measurement shall 26-32 mm or between the marks labeled A on the bow radius tool. Make sure that you are recording each of the values as you measure.

Proceed to point B or 457 mm up from the stem and take the measurement and repeat for each of the points [C - F]. Take the measurement for the Chine intersection which is marked on the tool and fin or between 311-387mm. If the chine is not visible because rounded, use a 1mt long flexible batten to extend it to the bow.



Measure back from frame fin 400 mm and measure the keel height [223-235mm] or thru the first locator hole on the measurement frame.

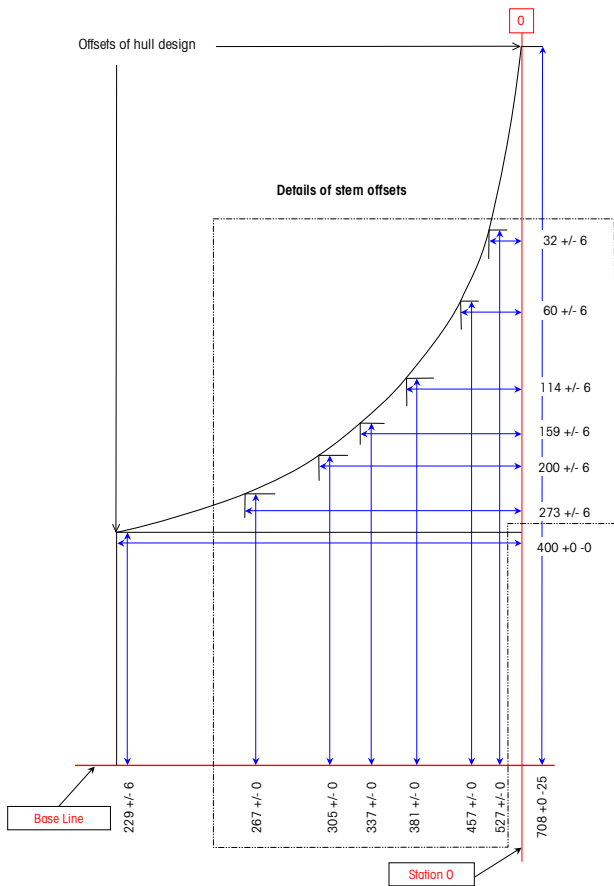

The intersection between the chine extension and the stem head shall be between 311 and 387 mm up from the base line.

Station Measurements:

Slide the cross member back to the line marked station 1. Drop the locator rod thru the hole at station 1 on the frame [be careful, don't drop the rod as you will definitely put a punch mark on the keel] and then lock the cross member. Locking the cross member will ensure that the cross member is 90° to the frame. With the rod in place note that only one of the two scribe marks are visible. **See photo.**

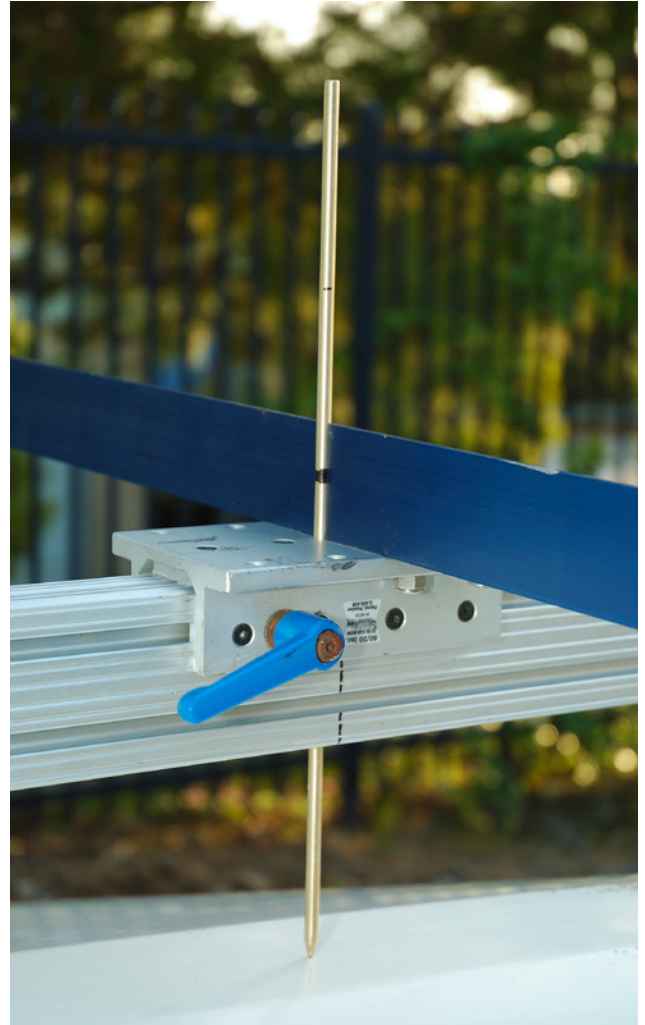

Measure down from the bottom edge of the cross member to the chine on each side and record the measurements on the measurement sheet **see photo.** For the sheer line measurement use the sheer tool and the squared edge to locate and mark the station location longitudinally on both the sheer line and the chine (these will be absolutely necessary for finding the width measurements).



Now find the sheer line measurement point by placing the sheer locator tool against the side of the hull with the pointed end hooking over the gunwale and the point resting on the deck. Use a carbon copy sheet to mark the line **see photo**.



Make a pencil mark at this point now pivot the tool so that it is parallel to the locator tool which should be hanging 90° to the cross member. **See photo**. (needless to say this is tricky at first).

Take the measurement reading from the black scribed line on the locator tool to the nearest millimeter and record the value on the measurement sheet. Repeat this process on the opposite sheer line. Remember that the measurement shall be taken from the top of the cross member.

Now unlock the frame remove the rod and slide the cross member aft to station 2. Insert the keel rod and lock the cross member. Repeat the same process performed on station 1 for stations 2 through 5. Be sure to record the measurement values onto the Measurement Data Sheet.





Daggerboard Case Measurements:

Using the transom sheer triangle or a large square, lower one end into the aft edge of the daggerboard slot and the other edge against the lower edge of the measurement tool to measure the maximum aft opening. **See photo at right.** This opening shall be between 2438 and 2464 mm aft of the stem or within the black band on the measurement tool. Also check that the aft edge of the slot is perpendicular to the base line of the measurement tool with a tolerance of 2mm at the top. The length of the slot shall be no more than 546mm and no more than 13mm wide. The front should be perpendicular with a tolerance of 6mm at the top of the daggerboard case.

This next measurement only applies to hulls built after 01 January 2001. Measure the depth of the case at the aft edge, this measurement shall be between 310 and 313 mm from the bottom of the hull. The top of the daggerboard case shall be parallel to the baseline with a tolerance of 2mm. To check this, place the small square against the aft side of the slot and mark the case height. Repeat the same procedure at the forward side of the slot turning the square. The distance of the two marks shall not be more than 2mm. **See photos at bottom.** No seals may be used except at the top of the slot.

Strips can be used either inside the slot or on the daggerboard to limit side movement. No carbon or exotic materials allowed. These strips cannot be used as retaining system.

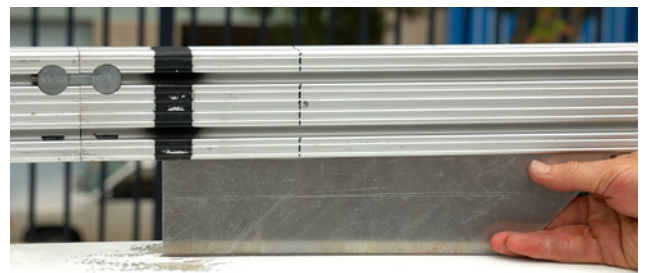

Aft Trunk Measurement



Transom Measurements:

Draw one line across the transom between the sheer lines [see finding the sheer line] across the transom and another line across from the chine corner to chine corner.

Using the large transom sheer triangle place one edge against the lower edge of the measurement tool [base line] and slide the triangle forward until it contacts the transom at the sheer line. This location is the maximum length of the hull and shall be between 4711 and 4737mm. The large triangle has one sharp and one cut edge, to check the maximum and minimum length allowed.

Make a pencil mark on the frame at the maximum length of the hull. Now find the end of the keel and make another pencil mark on the frame, then measure the distance between the two pencil marks, this is the transom horizontal offset distance who shall be between 203 and 220mm.

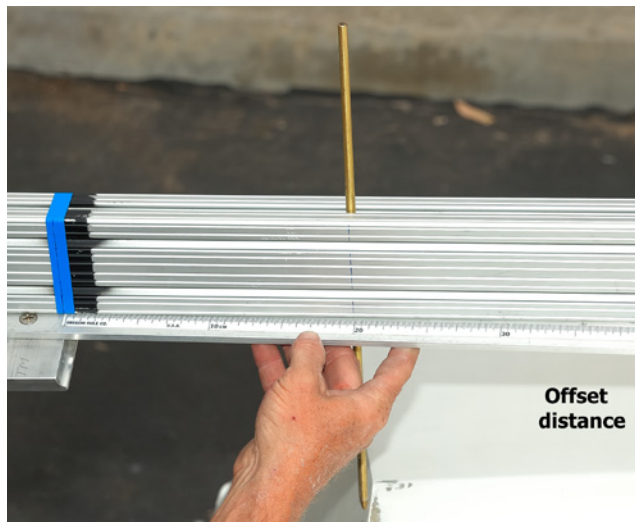

Measure the chine depth by using the chine [smaller] triangle and follow the same procedure as for taking the transom sheer measurement. **See photos at right.** The edges of the triangle are cut in a different way to show the maximum and minimum depth allowed. The drawn line should be between the two opposite corners.

Measure the widths of the sheer, chine and keel at the transom using a tape measure.

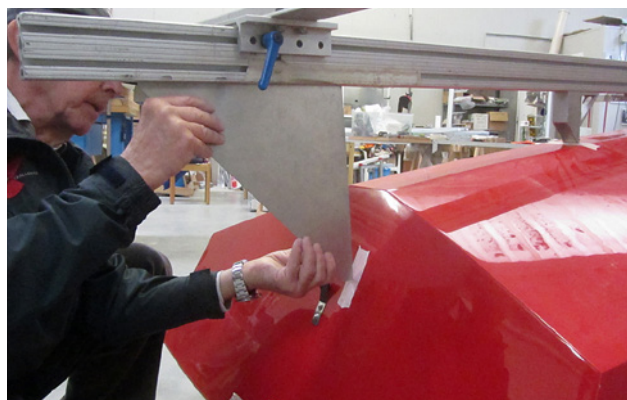
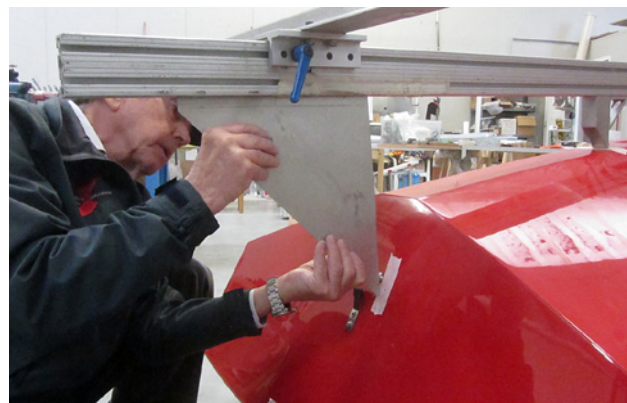

The sheer and chine depth at the transom can be measured by either the process used for the stations or simply measuring down to the drawn lines with a high quality rule.

Use the same rule to check the keel depth measuring down from the base line to the end of the keel, this shall be between 166 to 178mm.

Measure the distance from the top of the deck's height to the sheer, this shall be no more than 127mm.

To finalize the transom measurements it is smart to check that the rudder is hung at the proper depth by extending the keel to the Rudder Datum Point. It is quite a bit more difficult once the boat is back on her trolley. The keel extension shall cross the Rudder Datum Point with a tolerance of 6 mm above or below.

See photo in <Appendages> on page 42.

For boats built after 01 January 2001 the rudder gudgeons shall be mounted between 152 to 158 mm above the keel intersection for the lower gudgeon and from 407 to 413 mm for the upper gudgeon. The internal diameter of the gudgeons shall be between 8 to 8.5 mm.



Chine measurements

The chine is defined as the intersection of the extensions of the surfaces of the hull each side of the chine.

Chine depths [vertical measurements] are found sliding the cross member to each station and measuring down using a high quality ruler. Minimum and maximum at the stations are displayed on the Measurement Data Sheet.

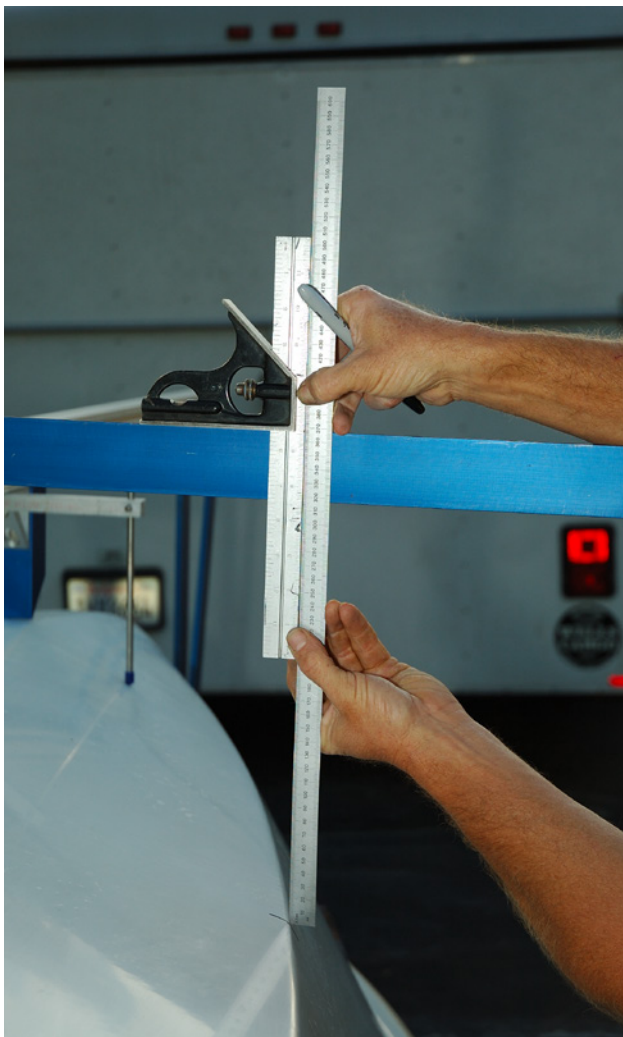

Chine widths [horizontal measurements] are found measuring with the large caliper the distance between the marks [see Station Measurements] at each station. The slider shall be between the corresponding marks on the large caliper.

When certifying the mould it is smart to check the actual measurement between the two tips.

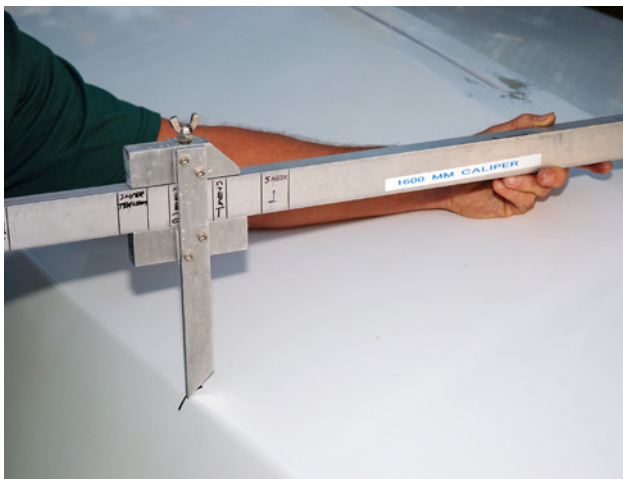

Hull transverse sections

The segments of any transverse section of the bottom and side panels from station 1 to 6 including the transom shall be straight with a maximum tolerance of 1%.

To perform this measurement you will need a very straight piece of bar. Simply place the bar in the field of the hull and measure the concavity (at the middle of the bar) or the convexity (at the extremities). The best way is to use a drill bit of the appropriate diameter. Check the total length of the section. The concavity or convexity (average of the two measurements above) shall be less than 1% of the length of the section. It is recommended that you take at least 6 measurements on each axis at various points on the hull.

See photos at top and middle.



Keel width

Measure the width of the keel flat with a tape measure and record the value on the measurement sheet. The keel flat shall be max. 102 mm aft of station 2. The keel may start to taper at station 2 to the bow, however the taper must be no less than 51mm at station 1. This measurement is to be taken on the outside of the keel. See photo.

See drawings at next page for further details.

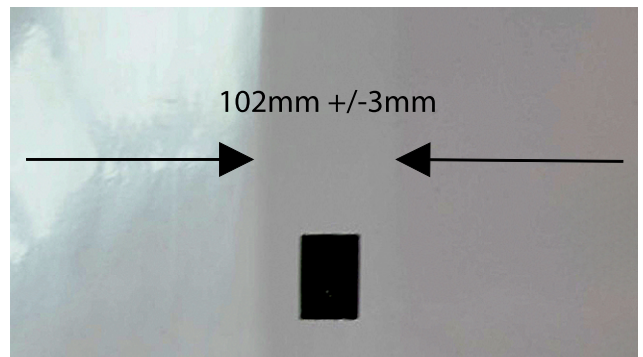

The hull measurements are now complete and the boat is ready to turn right side up. Before you do so, check to be sure that you have the Hull Datum Point mark and the sheer line marks for each station on the deck.

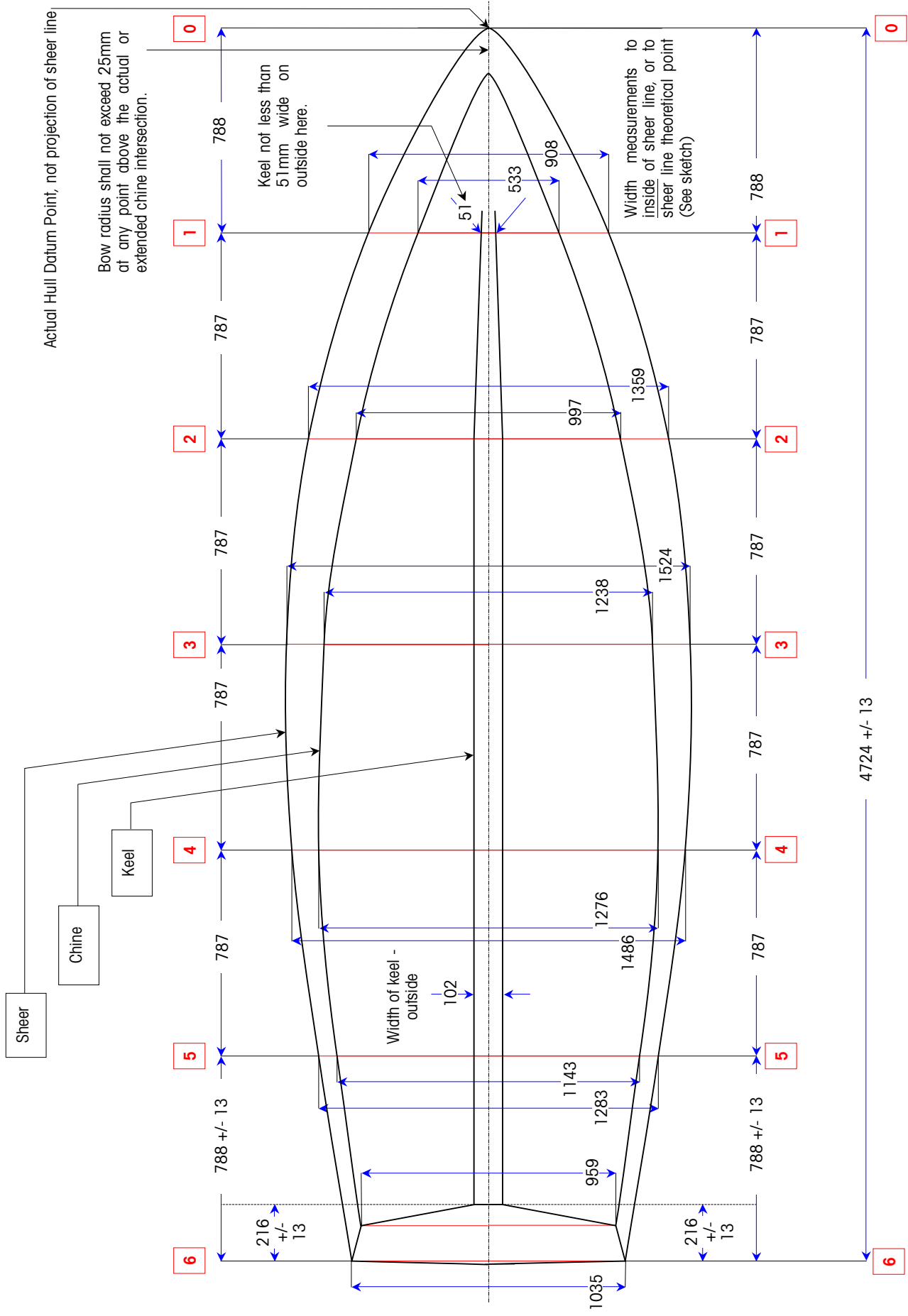

The following tolerances are allowed on the dimensions shown, unless a tolerance is shown on the drawing:

- Keel: +/- 6 on vertical measurements.
- +/- 3 on width, station 2 to stern.
- Chine: +/- 6 on height.
- +/- 6 on width.
- Sheer: +0 - 25 on height (including Hull Datum Point).
- +/- 13 on width.

Additional requirements: Refer to Rules.

Stay Rigging Point not less than 4470 mm no more 4572 mm above the mast datum point.
For boats built after January 1st 2001, 4860 mm - 4962 mm above the heel point.

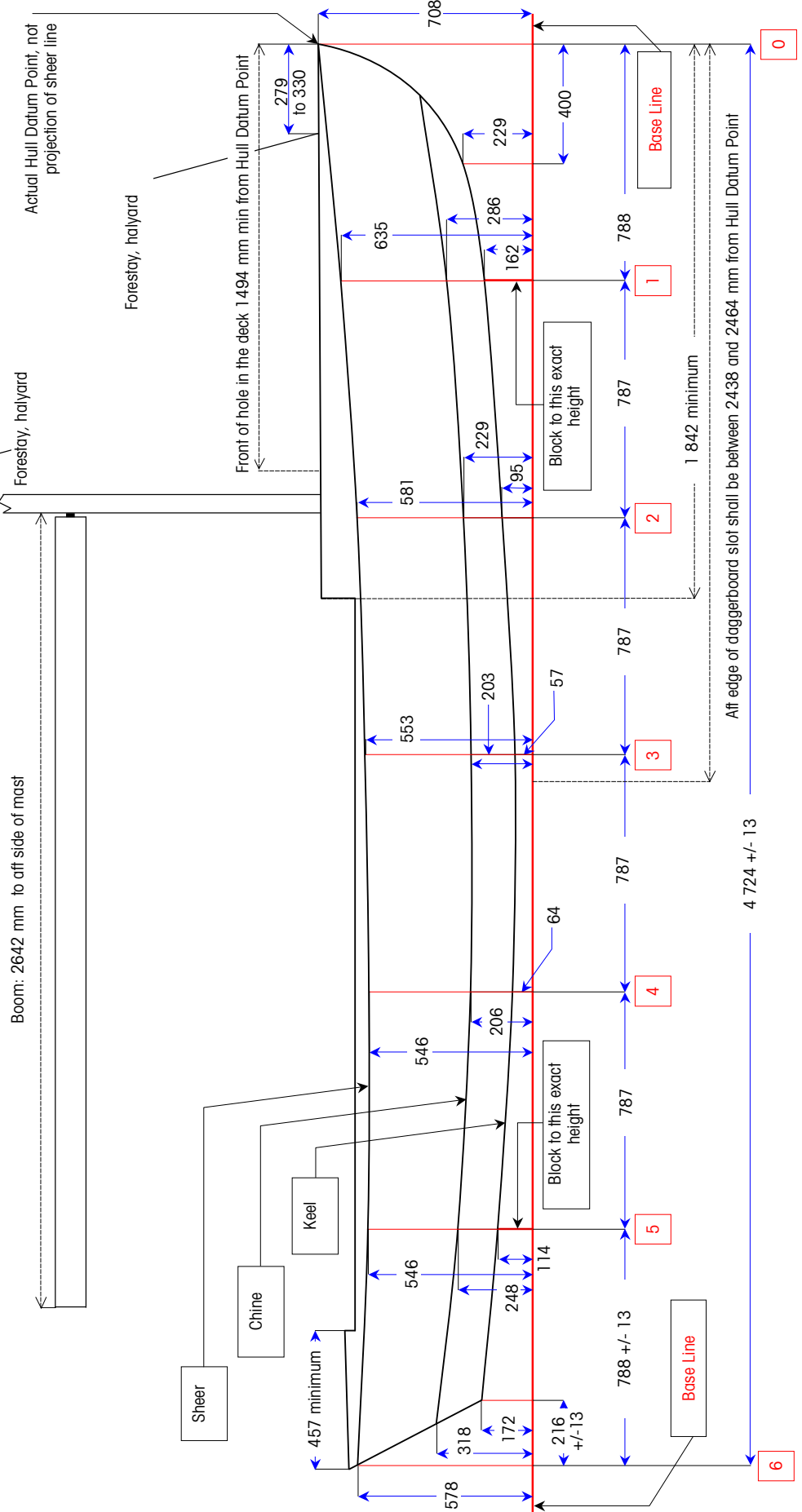

Deck Measurement

The deck measurements have many provisions for the huge amount of variations in the deck configuration; the basic measurements are detailed in the following instructions and should be treated as the default measurements. When a different or challenging configuration presents itself refer to the Class Rules for clarification. If the boat is built from 2001 it is of great help to set it horizontal placing a level on the daggerboard case.

Deck Width Measurements

Start by measuring each of the sheer lines widths from station 1 thru station 5 using the large calipers. Refer to the Class Rules or Measurement Data Sheet for these values. [See photos.](#)

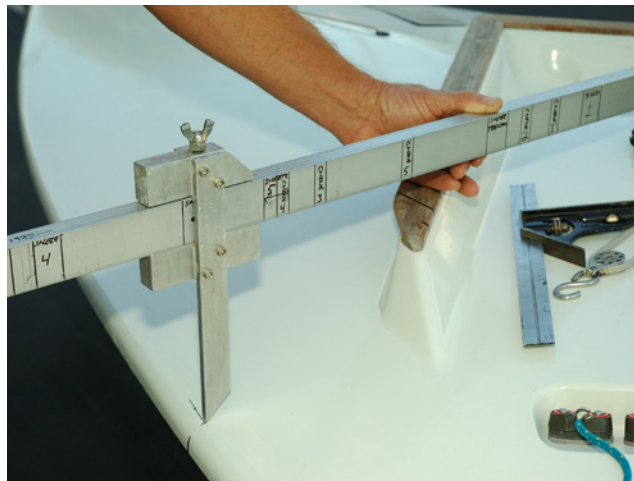

Now measure the width of the cockpit from the inside edge of the deck on the port side to the inside edge on the starboard side, this distance shall be no more than 1016mm. If the deck curves down with a radius, to find the measurement point place the large caliper on the sheer lines at the maximum width of the cockpit, measure down the distance from the top of the bar to the sheer line, add 51mm. The cockpit width shall be measured at this exact height.

The sheer strakes shall project no more than 32mm horizontally from the sheer line.

The gunwale maximum radius shall be 12mm.

Use the Sheer Locator tool to perform these last two measurements.

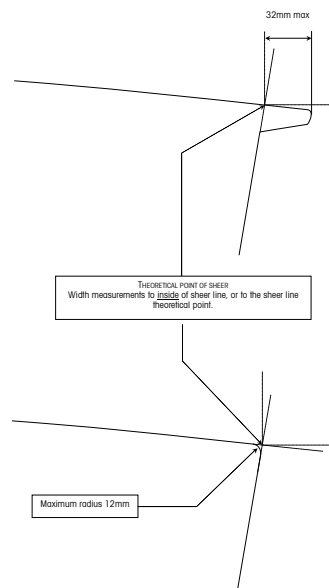

Deck Length Measurements

All length measurements originate from the Hull Datum Point at the stem and are measured perpendicular to the center line of the boat. [See photo at right.](#)



Shrouds attachment

When the attachment point for the shrouds is being measured, the measurements shall be taken from the centerline of the holes for both minimum and maximum lengths (1778mm to 1981mm). [See photo.](#) Use a tape measure to link both the forward and aft holes of the shrouds attachments, then use the large caliper to measure the distance from the Hull Datum Point to the tape measure.

The shrouds attachments can be either above or under deck no more than 102mm inside the sheer line: See Rule D.3.1(a).



Forestay fitting:

Starting from the Hull Datum Point the forestay fitting shall be positioned with the fore hole between 279 and 330mm aft hull datum point, measured parallel to the base line and no more than 45mm above the sheer line. Max diameter of fore hole 6mm. To measure the height of the fitting, determine the sheer lines at both sides. Then, using a straight rod slipped in the hole, check the height from the centre of the hole to the sheer lines on both sides. The average shall be less than 45mm. [See photo.](#)



Splash boards:

Measure the length of the splash boards, including curvature, they shall extend 610 mm from the center line on both sides of the deck. Within this length, the splash board height shall be at a minimum 51mm from the foredeck surface to the top of the splashboard.

Mast spar hole:

The forward edge of the mast spar hole in the deck shall be no less than 1494mm from the Hull Datum Point. The best method to take this measurement is to use the large caliper. **See photos.**

If less than 1494mm, an adequate plate shall be placed at the front of the hole to reach the minimum. The maximum size of the opening is 76 mm wide and 254mm long. Shims can be used to reduce the hole width.

Blocks or mechanical guys are permitted to control the fore/aft movement of the mast. Blocks shall be placed at deck level, other guys shall be connected to the mast below the lower point.

See Rule C.9.3(g).



Foredeck:

The foredeck must extend full width at the centerline to a distance at least 1842mm aft of the Hull Datum Point.

If the deck curves down with a radius, the actual length is taken at the intersection of the horizontal and vertical planes. **See Photo at right and at the top of next page.**

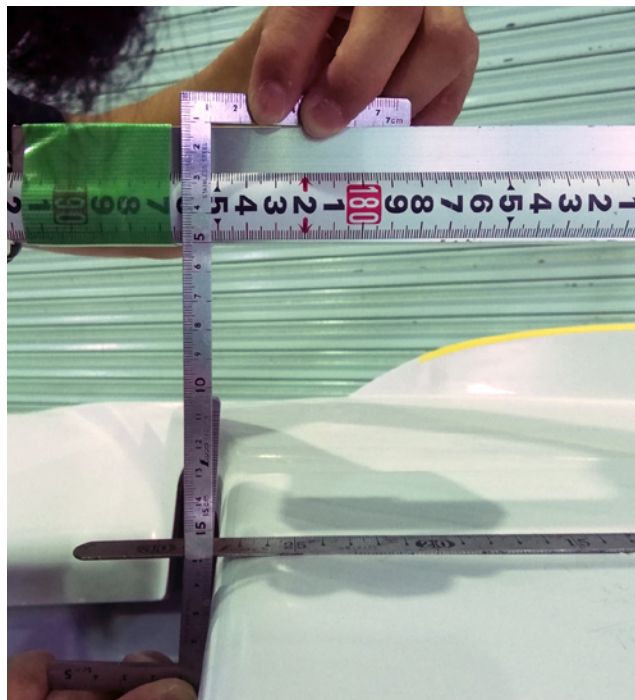

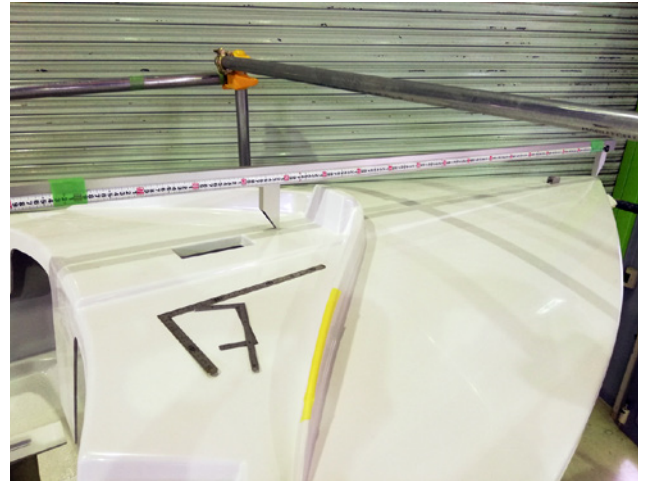

Afterdeck:

The afterdeck shall be no less than 457 mm forward of the actual transom [not sheer] [See photo](#).

The maximum height (camber) of both decks from the sheer is 127mm.

To check this measurement, place the large caliper on the sheer lines across the deck above the max camber. Measure from the top of the frame down to the sheer. Then measure the distance from the top of the frame to the max height of the deck.

Subtract from the first measurement. The result is the actual deck height .

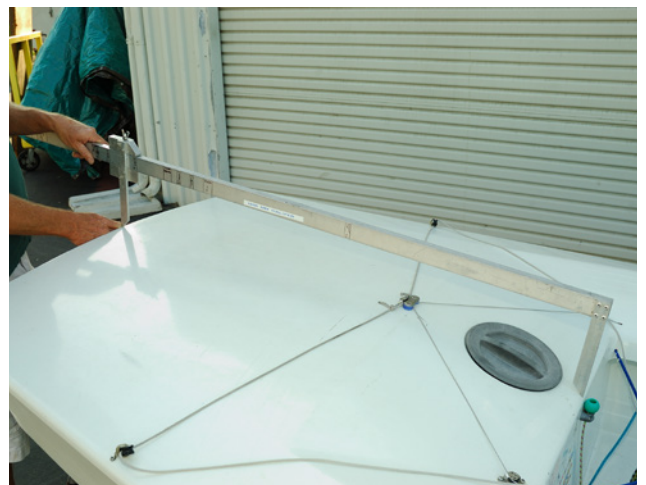

Deck Thickness:

The deck may be plywood or Glass Reinforced Plastic or a combination of the two. Check the Class Rule D.3.3 for the applicable prescriptions.

Mast step

Verify that the mast is stepped using only one transverse pin and the fore and aft movement of the mast is no more than 2mm in any direction. Any mast step is allowed, including those with a slider to adjust the mast position, providing that the slider is fixed with a bolt and nut or screw. [See photo](#)



Radius Measurements

Measure the established radiuses using the tool that is an arc of a circular sector. See Fig. 1. The one shown in the pictures is a sample. The tool should be made of aluminum or rigid plastic of at least 1mm of thickness to prevent any bending and with very sharp edges. This way the results of the measurements are very close to the same measurements made using CAD software.

The inner radius shall be the same as the radius to be checked (25mm for the bow, 19mm for the chine), the outer radius shall be enough to physically handle the tool.

The two tools shown in Fig. 1 have 25 and 19mm radius respectively and have a different angle of the arc. We suggest an angle of 75° for the 25mm and 55° for the 19mm tool. A smaller angle should give more accurate measurements, but the reading will be more difficult.

To check the radius, simply draw on each side the beginning of the curve with a pencil, then place one edge of the tool on that mark and move it to the same mark on the other side of the curve. See Fig. 2

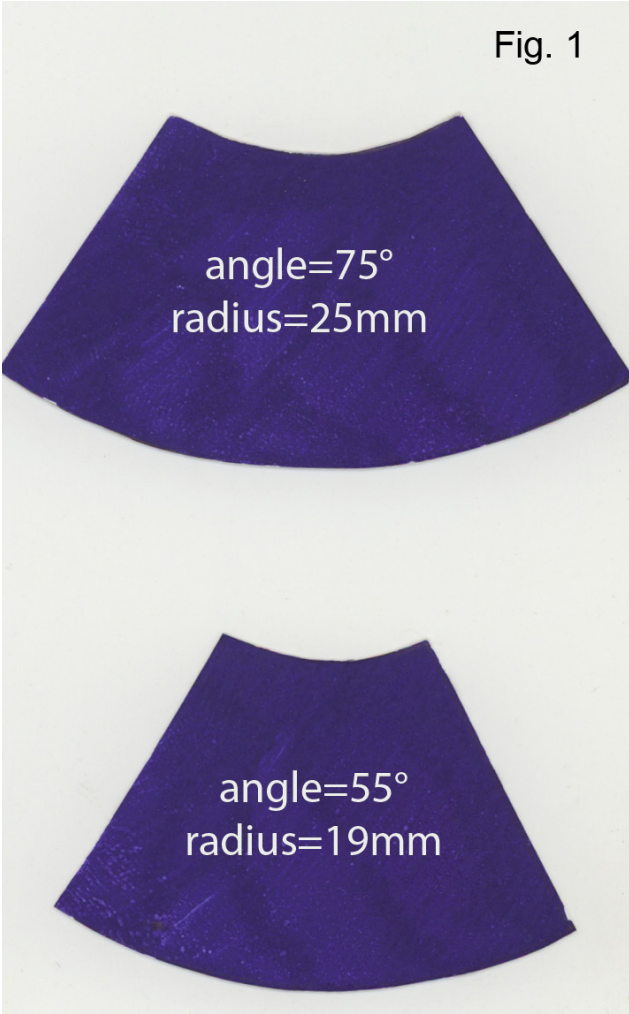

If the edges of the tool don't touch the surface, the radius is correct; if the edges of the tool touch the surface and there is space in the middle, the radius is greater than allowed; if the tool fits the curve the radius is the maximum allowed. See Fig. 3 to 7.

The same procedure, with adequate tools (with different inner radius) shall be used to check the remaining chine radiuses.

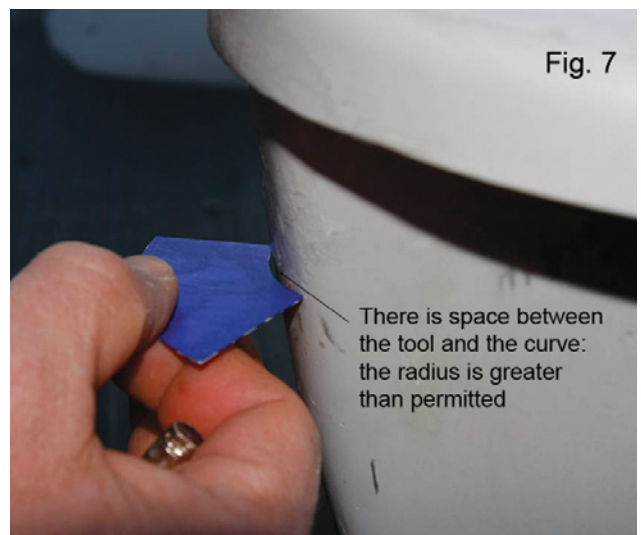
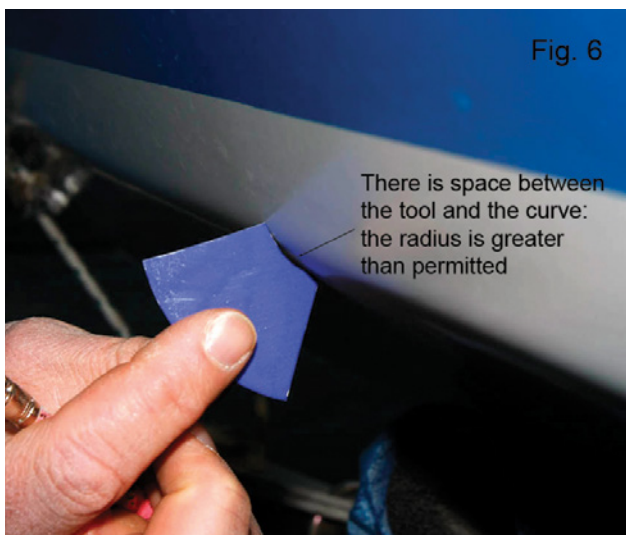
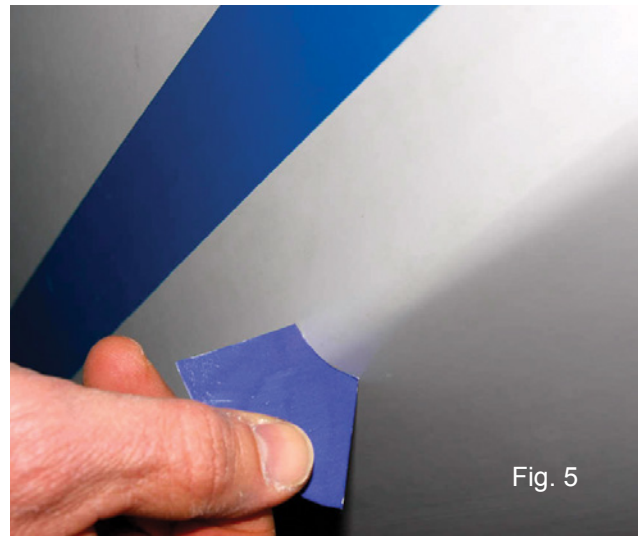
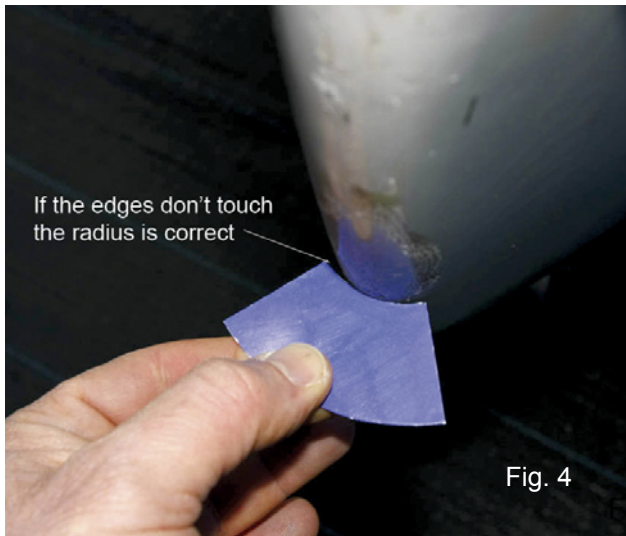
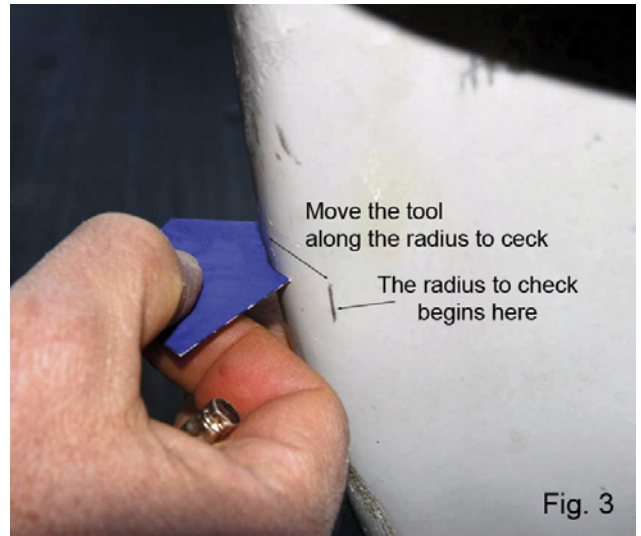

Moment of Inertia

Hulls with any optional and mandatory equipment and including hiking straps, any controls, mainsheet and compass if fixed on the hull, but excluding the jib sheet, shall be subject to the moment of inertia test (see Class Rules, Part III.H3). All hiking straps, sheets and control lines shall be in dry condition; the mainsheet shall be deployed as close as possible to the Center of Gravity on the cockpit floor.

The moment of inertia of the hull is calculated from the following formula:

$$I = \frac{CD^2T^2}{4\pi^2}$$

Where: I = Moment of Inertia
 C = Spring constant, kg/sec².
 D = Distance to axis, m.
 T = Time of one complete oscillation, seconds
 $\pi = 3.1416$

For our purpose, D = 2.6233 m.

The spring constant will be furnished with springs from SCIRA.

The maximum weight of the attachment shall be 350g excluding the springs only; if desired, corrector weights can be added to the aftermost part of the attachment to reach the maximum weight.

We can now simplify the formula to:

$$I = (0.1743m^2)CT^2$$

The minimum moment of inertia of the hull as determined from above formula shall be: 271 Kg*m²

Set the moment of inertia jig up on a hard level surface and check to see that it is reasonably level both lengthways and sideways. Also check the 2642mm dimension from the aft side of the riser to the front side of the 19mm dia. balance rod.

Carefully balance the hull by moving it back and forth on the balance rod so that the top of the deck is level with the horizontal line on the riser. Be sure to use a thin metal plate (152x152x3mm is recommended) between the balance rod and the keel. Also the spring attachment assembly minus springs should be in position on the fore deck. When the hull is balanced, attach the springs to the spring attachment assembly and then to the hooks on the riser, being careful to stabilize the hull while doing this operation. Adjust the spring attachment assembly so that the centreline of the spring bolt is 25mm from the aft side of the riser and clamp the assembly to the deck with the hook bolt through one of the holes in the forestay fitting. Recheck to see that the Hull Datum Point is level with the horizontal line within plus or minus 6mm and adjust the hull position if necessary.

The hull should now be free to oscillate about the pivot rod, being restrained only by the springs. Check this by displacing the bow approximately 76mm to 102mm above or below the horizontal and allowing it to oscillate. Please notice that an oscillation is one complete cycle, from starting point to farthest away point and back to starting point.

Proceed to time the hull oscillations through a minimum of 20 complete oscillations. It is better to start the cycles count and the stopwatch at the end of the first or second oscillation.

Divide the total time by the number of oscillations to arrive at the average time for one complete oscillation. If necessary, repeat this procedure twice to check that the average oscillation time is correct to the nearest thousandth of a second, starting with 76mm to 102mm bow displacement each time.

Using the average time for one complete oscillation, solve the formula for the moment of inertia.

If the hull moment of inertia does not meet the minimum, weight shall be moved to or added to the ends to bring it up to the minimum.



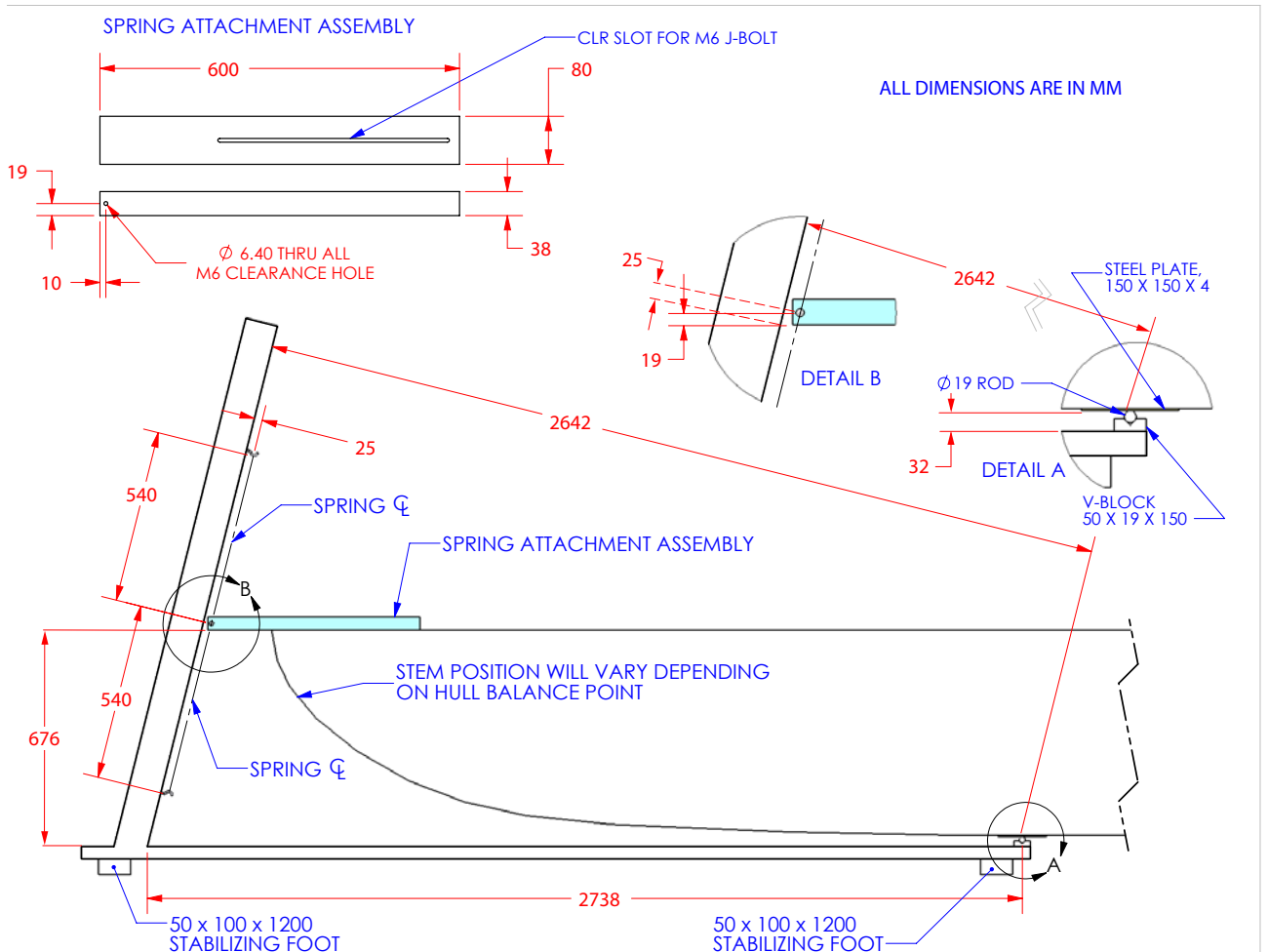

Rig

Mast Measurements:

It is better to measure the mast on the top of two long tables, separated enough so that the mast will lay flat on the table with the spreader bracket laying between the tables, *or on 3 easels at least*.

There are different rules that apply to measure masts; boats that were built prior to 2001 and those built after 1st January 2001.

Pre 2001 boats: Mark the Mast Datum Point (MDP) 6109mm from the upper point.

Locate and mark the sheer lines on each side of the hull about 1575mm aft of the Hull Datum Point using the sheer locator tool. Next place the large caliper (or any straight squared bar) on the marks to measure the distance from the sheer line to the mast step fitting. Measure down from the top of the crossbar to the mast step fitting and record the measurement. Next, measure down from the top to the side measuring points. If a squared bar is used, measure the distance on both sides and calculate the average. Subtract this measurement from the first one. The result is the distance from the sheer to the mast step, to be added down from the MDP. This is the maximum length of the mast from the upper point to the heel point (see photo at top).

2001 and later boats: The mast step in the boat shall be 390-400mm from the sheer. If required, check the measurement using the same procedure for pre 2001 boats. Place the mast on the table and take the measurements. The total length of the mast from the Heel Point to the Upper Point shall be 6499mm at maximum.

Measure the mast according to Class Rules C.9 and F.3 and additional limitations; be sure to check overall length, limiting marks location and dimension, spar section and dimensions, shroud, stay and halyard rigging points (see image at middle), stopper and for 2010 and later boats the gooseneck section.

For pre2001 boats these measurements are taken from the MDP.

For 2001 and later boats from the Heel Point.

See images at bottom on how to check the limiting marks .

Weigh the mast by finding its balance point; refer to Class Rule F.3.4 for the center of gravity. A maximum of 100g of corrector weights may be added to reach the minimum weight, providing that the spar complies to the CG rule.

For additional information on weighing, see the specific section at page 57.

Halyards shall be metal or fibre lines, but not PBO or carbon. Shrouds and forestay shall be either wire or rod. Any shrouds adjuster is allowed. The minimum forestay diameter is 2.5mm.

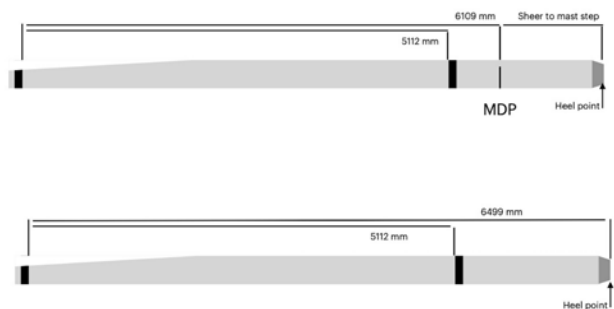
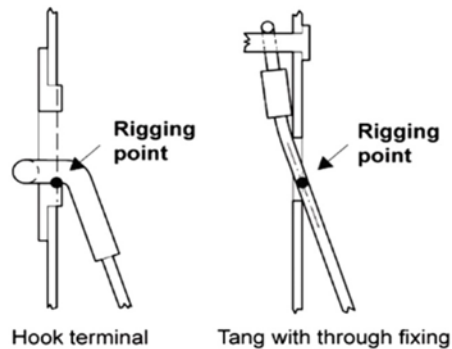
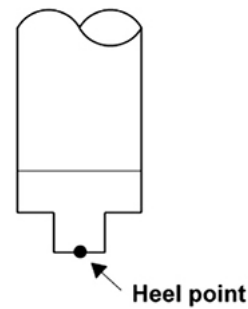

Boom Measurement:

Lay out the boom on the tables and slide it onto the gooseneck. All the measurements are taken from the aft edge of the sail slot. If the slot is cut, from its extension.

Using the small triangle, square the boom to the mast then check the length of the gooseneck. For 2010 and later boats this measurement shall be max 42mm.

See photo at top right

Then measure to the front of the outer limiting mark and then the overall length. See second and third photos at right

Other measurements to check for are the outer mark limit pin, limiting mark dimension and boom section dimensions.

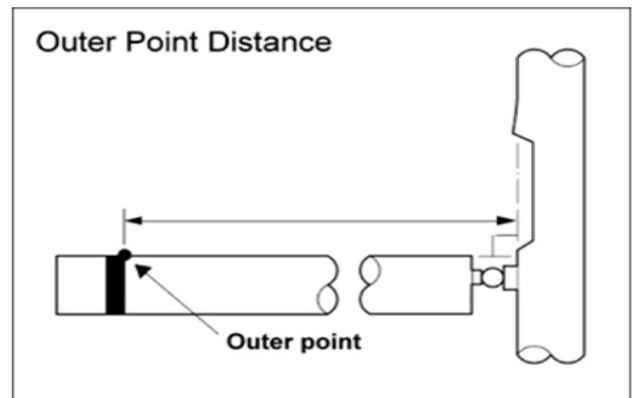

Don't forget to check the boom cut offs at extremities (max 45°) and the sail slot cuts (max 350mm). See the photo above. See also Rule F4.2.

**Whisker Pole**

This is also the best time to measure the whisker pole and pole launcher system. The maximum length shall be 2642 mm. Note that this measurement is an overall measurement. Also verify that the pole block isn't projected beyond the front of the mast.

See photo at right

See Rule C.9.5 for additional limitations.

The pole block support can be made out of any allowed material (see page 46 for further details).



Appendages

The use of Mylar or wooden templates will greatly simplify measuring the appendages. Having a large table for measurement will make the job more comfortable.

Rudder:

The rudder can be tricky to measure, make sure that the Rudder Datum Point and the front edge are properly aligned over the template. Measure the shape and thickness above and below the water line. Note it is important that the rudder be positioned with the Rudder Datum Point in the correct place as this serves as the basis for the shape measurements. The blade shape shall be between the maximum and the minimum allowed.

Hang the rudder on the gudgeons while the boat is up side down for its hull measurements and check that the rudder is parallel to the transom – with a max tolerance of 2mm (See photo at bottom left) - and that the Rudder Datum Point is positioned correctly within the tolerances of the rule (+/- 6mm) (See photo at bottom right).

Other items that will need to be checked are:

- weight of the rudder and corrector weights,
- retainer pin for both the tiller and the rudder and
- pintles diameter.

Refer to Class Rules C8.5, E.3.3 and E3.4.a for allowed tolerances and specific restrictions on rudder shape.

Remember that boats built before February 26, 2018 can use any allowed shape. Boats built beginning that date shall use the current shape.

The tiller shall not protrude from the rudder head more than 2mm and must be firmly fixed above the deck. It can slide fore and aft no more than 2mm.

See Rule C.8.5 for additional limitations.

For further information on weighing, see the specific section on page 57.

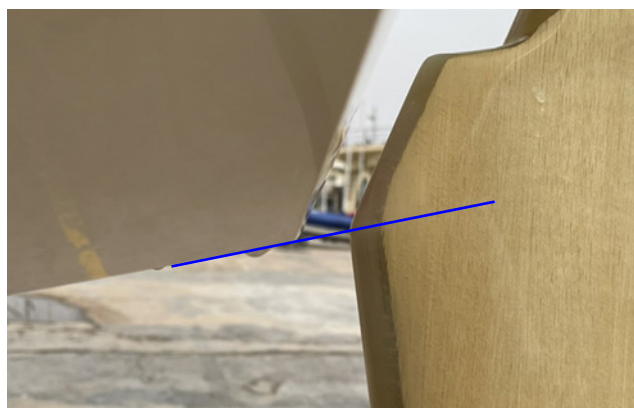
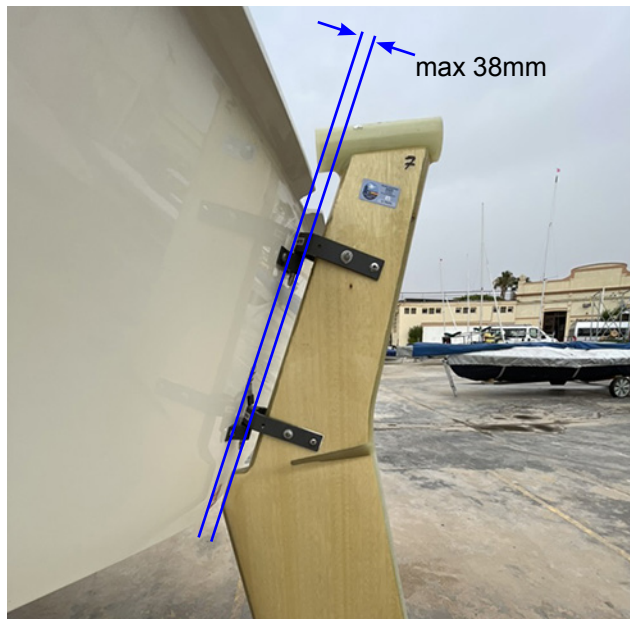
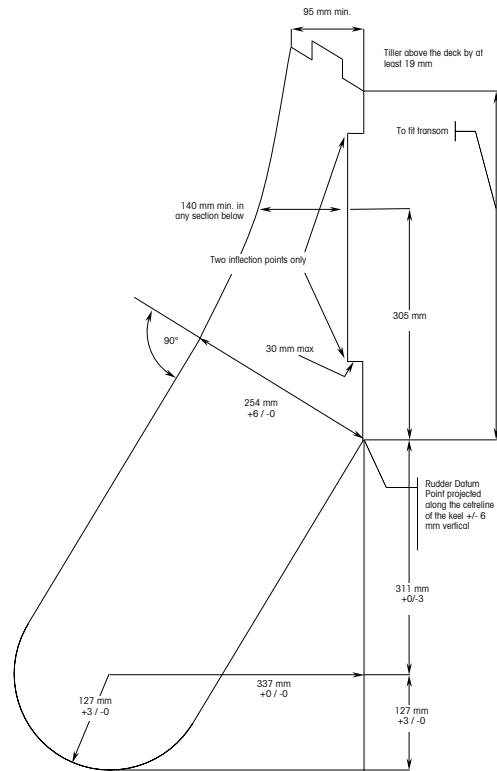

Daggerboard:

Lay the daggerboard over the template and check the dimensions, tapering and punch mark.

Note: to accurately check the taper use a combination square with the straight edge on the surface of the blade and the frame portion resting against the edge. 25mm is *the maximum* allowed by the rules.

Measure up from the bottom of the blade 851mm and permanently mark the blade with center punch. Check that the daggerboard does not protrude below the keel any further than the punch mark. The easiest way to check this is to measure the depth of the slot at the aft part of the case and from the punch mark to the stoppers on the blade. They should be equal. For boats built beginning January 1st 2001 the measurement shall be 310 - 313 mm.

Ensure that the daggerboard hangs perpendicular to the baseline (note this is not the keel line) using the measurement taken when the boat was upside down.

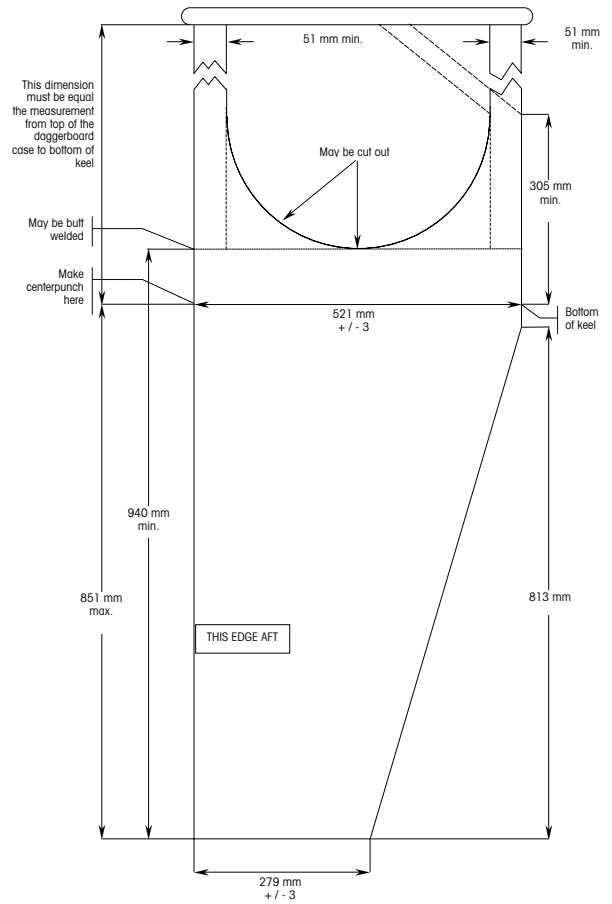

Verify that the retainer to set the daggerboard height is either a tablet or a hook with cutouts on the daggerboard.



To check on the water the compliance of the board maximum retracted position, a full width contrasting stripe 25mm high shall be marked with paint or an approved tape in a contrasting colour on each side of the blade perpendicular from the leading edge. No felt pen markers are allowed. The tape must have been specifically approved by SCIRA on a case-by-case basis. The list is promulgated as a Circular Letter by the SCIRA Technical Committee Chairman.

There are two methods to draw or to check the position of the stripe, depending on the year of manufacture of the boat:

For boats built before 2001, the best is to turn the boat 90°, insert the board into the case until 305mm protrude from the keel and mark the stripe position at the maximum deck height. This method is often unapplicable, so the easiest way is to check the daggerboard slot height at the forward part of the case and the height of the top of the deck at the boat centerline from the top of the forward part of the daggerboard case. Sum the two measurements, add 305 (max board position up) to get the position of the upper part of the stripe. The latest system has a maximum error of 5mm.

For boats built from 2001, add the established measure of 615mm to the height of the top of the deck. This height shall be taken at the boat centerline from the top of the forward part of the daggerboard case. This is the position of the upper part of the stripe. The top of this band shall be even with the topmost surface of the deck when the board is completely retracted (at max height). (See photo at middle). See Rule C.8.4

Verify that there is a suitable safety line so that the daggerboard may be raised only to its legal limit while racing. The line shall be directly fixed to the daggerboard case and connected to the blade with a metal shackle or carabiner. The length of the safety line shall be 610mm from the top of the daggerboard case to the inner part of the shackle pin. The minimum diameter shall be 4mm if rope, minimum 1mm if wire. It shall be a single piece and shall not be adjustable. See Rule C.8.4 for further details.

See photo at bottom.

The hole on the daggerboard to connect the safety line shall be above the line connecting the lower side of the stoppers.

Knots are not allowed along the line, except to connect the line to the shackle or the carabiner. If a knot is used, the excess shall be cut or sewed.

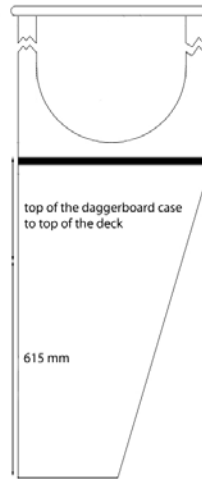

2001 and later

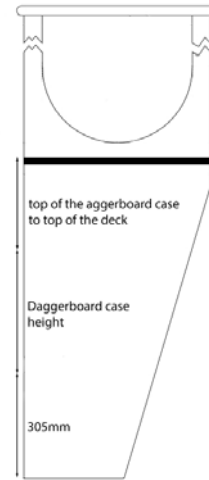

before 2001



Check the position of the hiking straps. The hiking straps are Optional Running Rigging (See Rule F7 for further details and the optional rigging). Any hiking straps or any kind of line or cord is allowed providing they are attached to the boat. The location and number of hiking straps is free. (See photo at right)



A single line looped around the daggerboard handle to facilitate hiking is allowed (See photo below).



Safety Equipment

Check that the Snipe being measured has a useable paddle and a 15 meters x 8mm floating single piece tow line. The line shall be secured anywhere in the boat (but not inside the watertight compartments) while racing.

Each Snipe must also carry two personal flotation devices to the minimum standard ISO 12402-5 (Level 50), or USCG Type III, or AUS PFD 1, or EN 393, unless an equivalent standard is prescribed otherwise in the Notice of Race. When checking the buoyancy aid compliance, verify that the size and weight are correct for the crew. See photo at right.

SIZE / GROSSE		SEE COLLAR/ Siehe KRAGEN			
h	s	M	L	XL	
170-180	80 - 115	80 - 115	95 - 130	95 - 130	
160-170	45 - 75	55 - 85	70 - 95		
150-160	60	60	60	60	

Carbon or aramid fibres

Carbon or aramid fibres can be used only in fittings and their supports, running rigging (see Rule F.7), tiller extension (see Rule C.8.5.a.6), splashboard (if not moulded with the boat, see Rule D.1.5) and in the compass support (see Rule C.5).

Ropes can contain carbon or aramid fibres. Halyards cannot be made out of carbon or PBO (see Rule F.7). See the above mentioned Class Rules and the World Sailing Equipment Rules of Sailing for additional details.

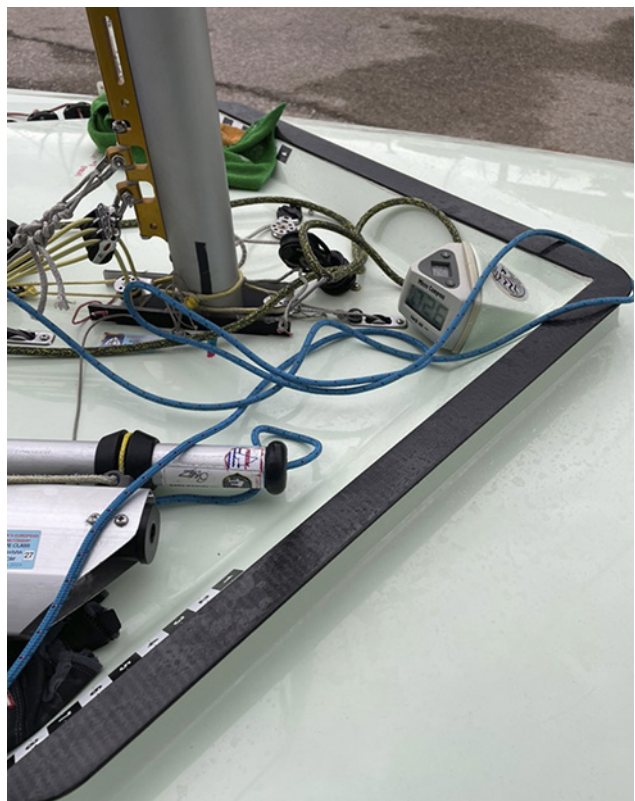

Miscellaneous:

Any shroud adjusters are allowed, providing that the shrouds length isn't adjusted while racing (see photos below and at top right).

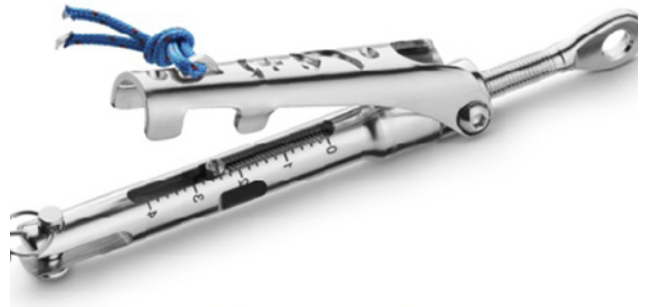
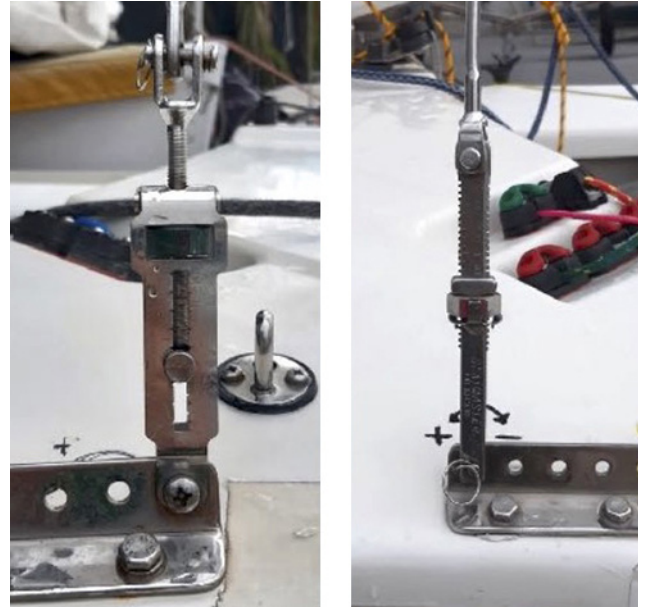

The jib shall be attached in such a manner that it can be disconnected without disconnecting the forestay (see photos at bottom right).

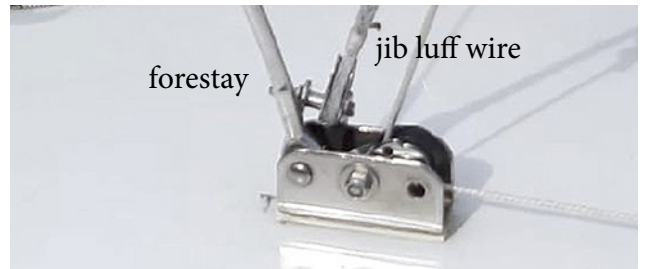

Hull numbers shall be engraved on the daggerboard trunk in digits minimum 13mm high. Boats with a removable carter shall engrave the hull numbers in a visible non removable part of the cockpit floor (see photos below).



Sails

Measuring the sails is fairly simple and follows the World Sailing instruction for sail measurement. The tools you will need are an 8m metal tape measure, a high quality ruler and a set of jib head, tack and clew templates. You may also need a paper tape or other appropriate tool to properly locate the head, clews and tack points on both sails (see photos at bootom right).

Main sail

Start by laying out the main on a very large table or on a floor.

Now remove the battens. First measure the leech dimension from the head point to the clew point. Tension the sail to remove wrinkles. Record the measurement. Flutter patches can be added to the leech with a max extension of 215mm. Check that the leech shape between the battens is straight or hollow (see photo at top left of page 51) folding the mainsail according to photo at mid bottom on page 52.

Fold the sail in half laying the head point over the clew point. Remove all of the wrinkles by gently stretching the sail so that a clear crease at the half way point, mark the point with a pencil. This is the middle width measurement point.

Move the head to the half width mark and place the head point on the pencil mark. Remove wrinkles and straighten the leech and make a mark at the half way point, this will be the upper quarter width measurement point (see photos at top left, page 50).

Move the clew to the half width mark and place the clew point on the pencil mark. Remove wrinkles and straighten the leech and make a mark at the half way point. This mark is the lower quarter width measurement point.

The sail is now ready to measure the widths. Take a tape measurer and measure across the widths by leaving the end of the tape at the mark on the leech and laying the tape across the sail to the nearest point on the luff including the boltrope (roughly perpendicular to the luff). Swing a short arc to be sure that at the shortest point the dimension is not greater than allowed (see photo at top right, page 50).

Repeat this for the upper, middle and lower quarter widths.

Now measure the batten pockets, they shall be no more than 38mm than the max batten length (see the drawing on the next page for specification) (see photo at bottom left, page 50).

The center of a batten pocket shall be defined as the free space between the inside part of the stitching lines in the pocket.

Measure the three battens with a tape measurer and record those measurements.

Measure the dimension at the top of the sail, the top width including the boltrope shall be no more than 185mm. Also check that the top of the sail is no more than 90° from the luff (see photo at bottom right, page 50).

Verify that the boltrope at the tack is cut off no further than 254mm from the tack corner. The boltrope at the head and at the clew shall be cut off perpendicular and even to the ends of the sail.

The minimum weight of the cloth or laminate allowed for mainsails is 130 gr/sqm. *There must be a sailmaker's stamp to certify the minimum weight.*



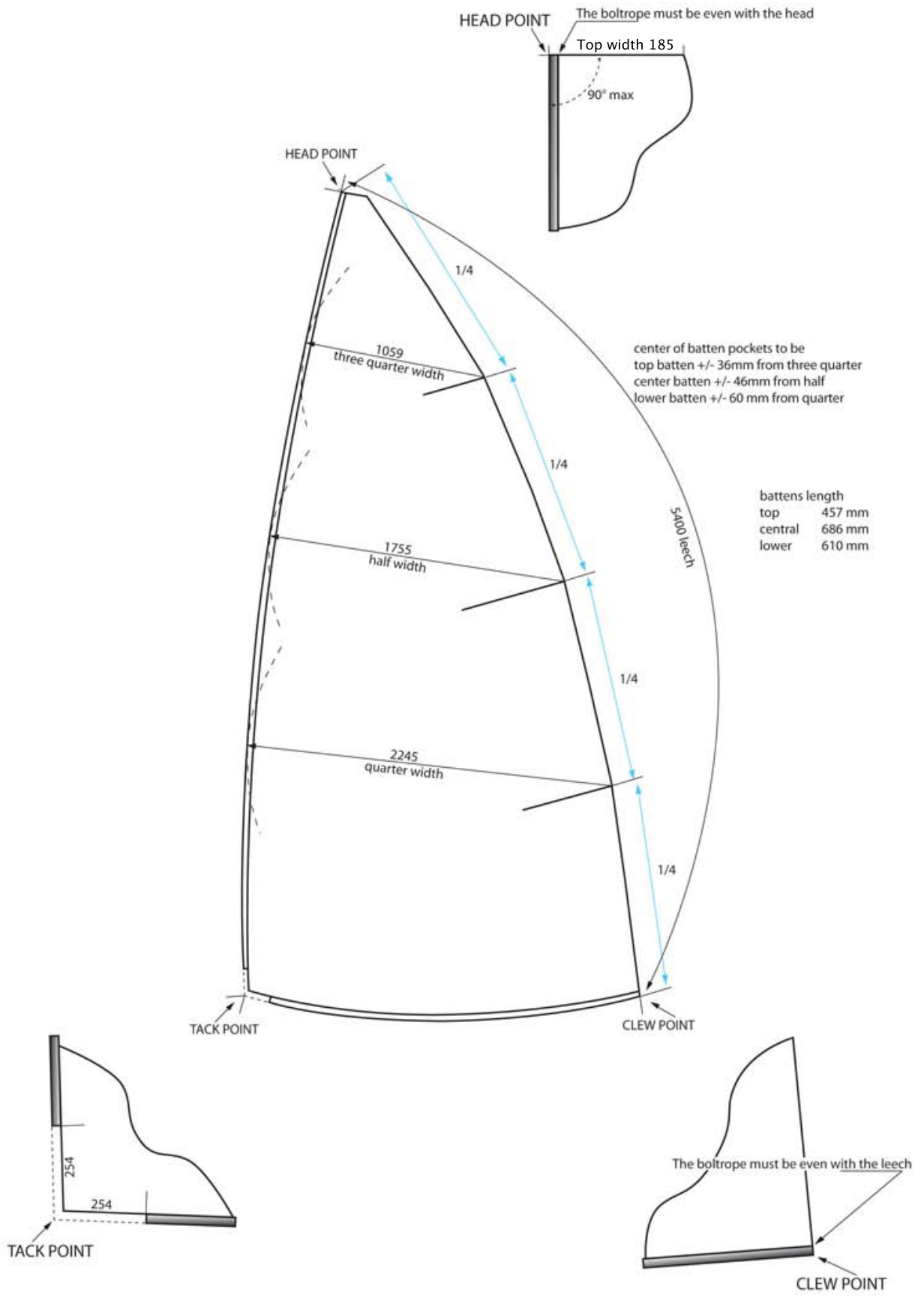

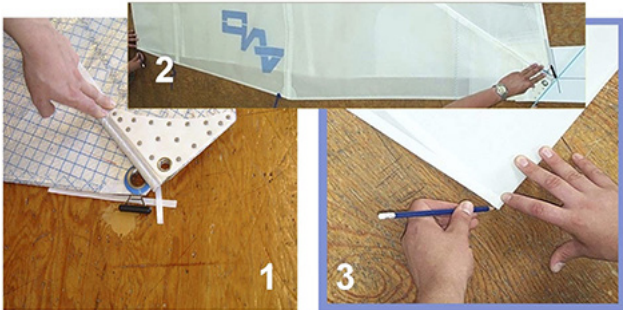
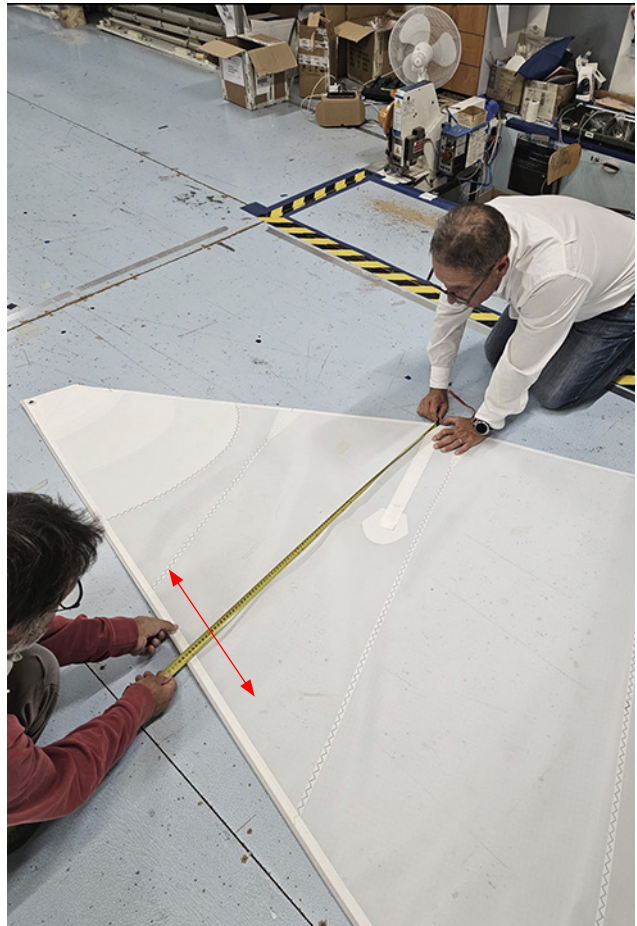

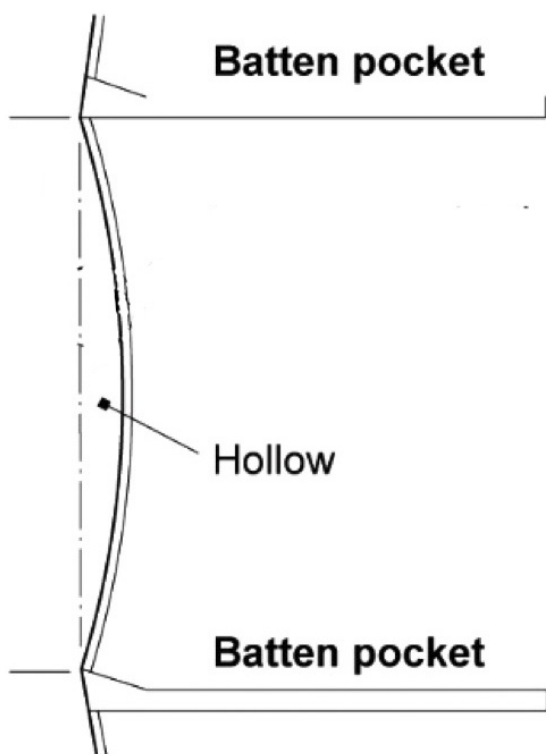

Identification

According to Class Rule 10.3, 10.4 and WS RRS Appendix G:

- the class insignia can be placed back to back;
- no restriction about the colour provided it is clearly legible;
- national letters and sail numbers shall be in capital letters and Arabic numerals, clearly legible and of the same colour;
- the height shall be 300mm and the space between adjoining characters shall be 60mm;
- the typeface shall be commercially available giving the same or better legibility than Helvetica;
- the position of national letters and sail numbers shall be inside a radius of the 60% of the leech length centered on the head point of the sail with the right side uppermost, but the Class Rules specify that both national letters shall be above the sail numbers (this changes the RRS).

To summarize:

- above the top batten, the emblem, every color is accepted (providing it is clearly legible);
- below the top batten, the national letters, those on the right to be above those on the left side; colour to be the same as the numbers;
- straddling the mid batten, the sail numbers, the right ones to be above the left ones.

For sails measured after February 26, 2018, according to WS Q&A 2018.004, digital-like fonts are not allowed.

The letters on the mainsail shall be as prescribed by World Sailing Regulation 19 at the moment of registration to SCIRA for the current year.



Jib

The jib perimeter is measured as well as the head, the mid foot to head and the middle width. Start by folding the jib in half from tack to clew so that the tack point and the clew point match, using a pencil make a mark at the crease at mid foot, remember to straighten away any wrinkles that may affect the measurement.

Lay out the jib on a flat surface and remove as many of the wrinkles as possible.

Using a tape measure from the head point, measure down the luff then the mid foot and lastly the leech. Remember that you are measuring from the head point to respectively the tack, mid and clew points (see photos at the top of page 54).

Flutter patches can be added to the leech with a max extension of 215mm.

Now measure the foot of the jib from the tack point to the clew point and record all these measurements.

Then measure the mid width by folding the jib so that the head point matches the clew point. Mark this point with a pencil. Take a tape measure and measure across the mid widths by leaving the end of the tape at the mark on the leech and laying the tape across the sail to the nearest point on the luff (roughly perpendicular to the luff). Swing a short arc to be sure that at the shortest point the dimension is not greater than 1025mm (see photo at bottom left, page 54).

The last measurement is the head of the jib, this area of the sail is always built very close to the maximum dimensions. From the head point measure down 155mm along the luff and the leech marking each with a pencil. Now measure the distance between these two marks. The maximum dimension is 115mm. Check that the top of the jib is no more than 30mm and is max 90° from the luff (see photo at bottom right, page 54).

The jib and foot leeches must be a uniform curve. To properly check the leech curve, fold the jib along a vertical line to flatten the cloth and verify the curve. (See explaining photos at bottom left and middle).

The minimum weight of the jib cloth or laminate is 160 g/sqm. There must be a sailmaker's stamp to certify the minimum weight (see photo at bottom right).

The jib can be measured with or without the luff wire or line. When racing the wire or line shall be firmly fastened to the jib cloth (See Rule C.10). Any system to slide or move the jib along the wire or line is not allowed except a cunningham (See Rule F.7.2, Running Rigging).

Sails can have transparent windows of max 0.2 sqm. The area includes stitching and/or gluing:

APPROVED MYLAR LAMINATES AS FROM JANUARY 1, 2024

The list is updated through a Circular Letter signed by the Chairman of the Technical Committee, posted on snipe.org, Rules section.



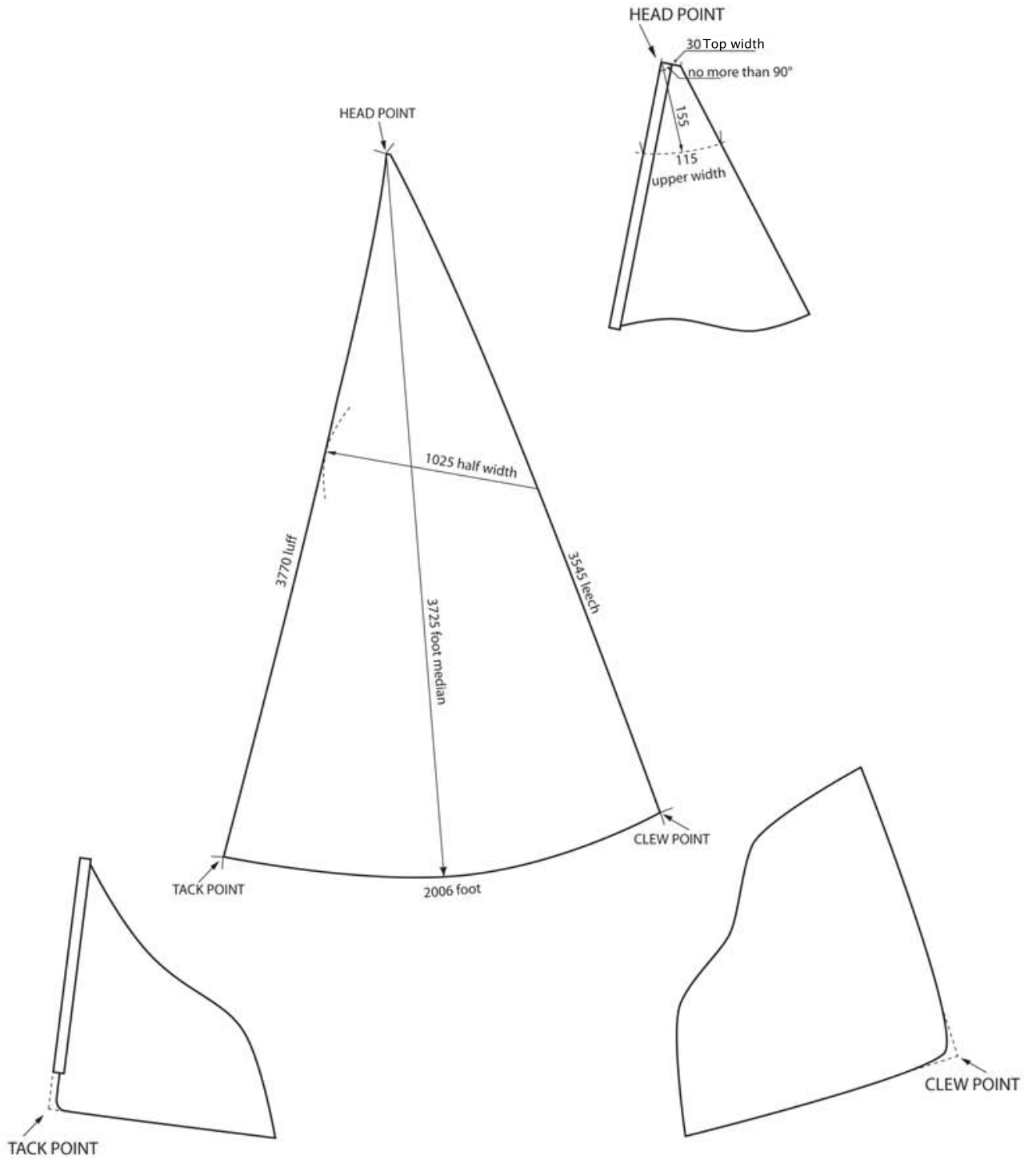

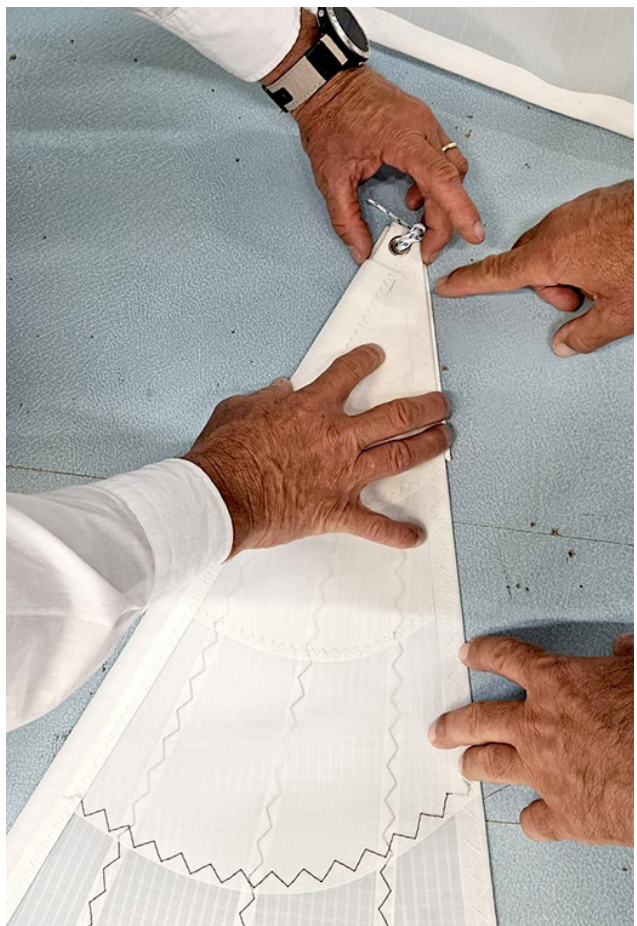

Weighing

Boat

Tools needed

- A scale of 200kg minimum load, either conventional or electronic. In a championship the scale should be checked before the weighing session.
- Hanging system, whose weight shall be set as tare on an electronic scale or subtracted from the total weight on a conventional scale.

The boat shall be presented in dry conditions (no water inside, no wet sheets...) with the following equipment:

- Hull fittings and equipment
- mast, complete with rig and fittings
- boom and whiskerpole
- main and jib sheets
- rudder, tiller and extension
- daggerboard
- compass

The following equipment shall not be included:

- Safety equipment (Paddle, Towing Line, 2 Personal Flotation Devices)
- Personal tools or equipment

The minimum weight in the above conditions shall be 172.8 kg.

Remember that every scale has a deviation, which must be counted. If the deviation is, say, 0.1%, the scale error is about 200gr. This means that a boat is in compliance if the weight shown is 172.6kg.



If not the minimum, corrector weights shall be added in any position to meet the minimum MOI. The corrector weights shall be visible. If inside the watertight compartments, they shall be visible through the inspection ports. Visible means that the corrector weights could be inspected, eventual markings checked or their approximated dimensions calculated (see photos at top and middle).

For boats built after January 1st, 2024, corrector weights shall be a multiple of 0.5kg. Fractions of 0.5 kg are NOT allowed.

If a boat already has a Measurement Certificate, there is no need to check the MOI again.

If the weight is above the minimum, the exceeding corrector weights can be removed, but the the MOI shall be checked again.

During a championship or a regatta, changes in the corrector weights placement or amount is NOT allowed.

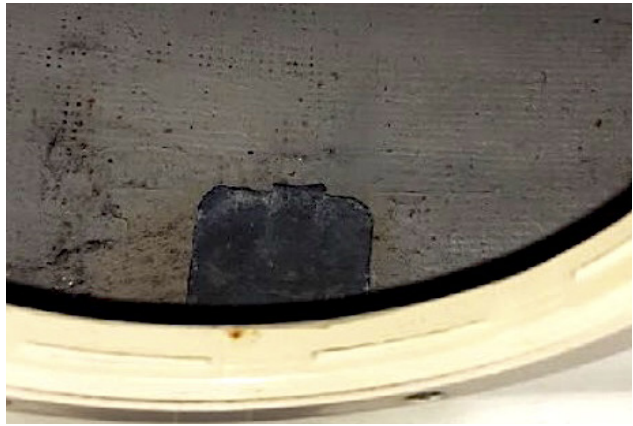

The amount and position of every corrector weight shall be marked on the Measurement Certificate and shown on the specific label inside the cockpit.

(See photo at bottom)

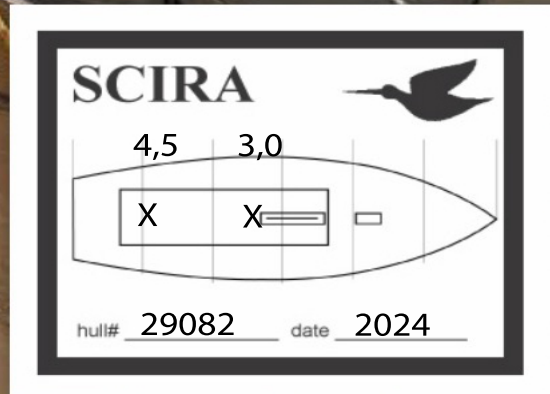

Mast

Tools needed

- Any suitable scale with 20 kg minimum load (a luggage scale or a personal scale are recommended).
- Any suitable system to support the mast (a latch or a triangular prism for example)

Shrouds, shrouds adjusters, spreaders and forestay shall be in place, the rig shall be tied and fixed at the Lower Point using tape. The exceeding rig shall be left free to rest on the ground.

Halyards shall be inside the mast. The exceeding shall be left free to touch the ground ([see image at right](#))

The whiskerpole pulley and the related equipment is included in the mast weight. The compass, its support, the wind indicator and any other fitting are not included in the mast weight.

The mast is placed balanced or hanged on the scale. The balancing point shall be above the maximum Centre of Gravity distance from the Top Limiting Band allowed (3588mm) ([see image at right](#)). The balancing point shall be checked with the full rig in place.

If the mast doesn't reach the minimum weight of 9.1 kg, corrector weights up to 100 g must be placed anywhere to comply with the Centre of Gravity requirement.

The amount and position of the mast corrector weight shall be marked on the Measurement Certificate.

For masts manufactured after January 1st, 2024, an additional requirement shall be reached: the bare mast weight shall be 7.9 kg. The bare mast doesn't include spreaders, shrouds or stay with their corresponding hardware, any type of support for the compass, any type of support and pulley for launching the whiskerpole.

This rule will be effective beginning 1st January 2028.

Rudder

Tools needed

- Any suitable scale with 10 kg minimum load (a luggage scale is recommended) [see photo at right](#)

The minimum weight shall be 2,72 kg, including pintles.

If the rudder doesn't reach the minimum, corrector weights shall be added in any position according to the following scheme:

- for hulls built until December 31, 2012 max 450 gr
- for hulls built from January 1, 2013 max 250 gr

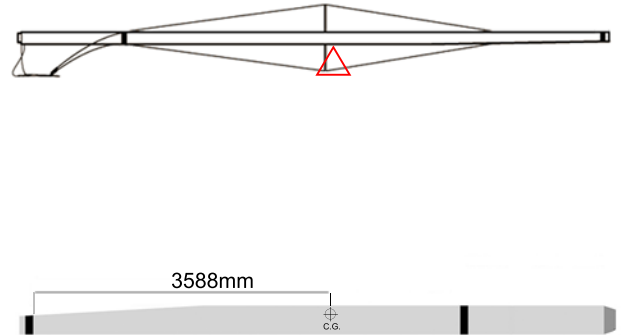

Equipment inspection at events

Whether it is a national or international regatta, the following should be observed and organized:

The following are the minimum equipment inspections to be conducted at each level of event:

Sanctioned Regattas:

- verify that the boat has the SCIRA decal
- verify that all sails are measured and have the royalty labels
- verify the safety equipment: 2 personal flotation devices, a paddle and a single piece floating towing line of 15 meters length by 8 mm diameter

National and International Championships:

- International Championships: boats are required to check sails stamps, decals, paddle, tow line and personal flotation devices at minimum, unless differently stated in the appropriate DoG. No more than two suits of sails per boat may be measured. It is strongly suggested to use a stamp of the championship. Ensure that the proper sail cloth is being used. The same boat and measured equipment must be used throughout the entire event. Petitions for replacement of irreparably damaged equipment shall be addressed in writing to the Race Committee.
- Other championships: in addition to the lower level are required to inspect boats according to the specifications below:
 - **Level 1** - North Americans, South Americans and National Championships: correctors weights, daggerboard safety line and retaining system, mast step, rudder security system.
 - **Level 2** - WH&O and Open European Championships: weight, sails, daggerboard, jib tack.
 - **Level 3** - Open and Junior World Championships: rudder, mast, boom, pole.

At Level 2 and 3 Championships the measurement committee may also:

- fully measure at least one hull of each builder
- check MOI

At discretion of the Technical Committee of the event, one or more of the measurements of the higher level of competition may be established, providing it is indicated in the Notice of Race.

At Championships the measurers act as equipment inspectors. Thereafter the boat cannot be modified in a manner in which would require re-measurement.

Remote Measurements (RM)

In events where a high number of competitors is expected it may be advisable to split the measurements in two sessions:

1. @Home Controls, held in the competitors' home country by measurers appointed by the National Secretary;
2. On Site Controls, held in the event's venue.

What to inspect @Home or On Site depends on many different factors (availability of adequate areas for the measurement, volunteers and so on) and it's in the Chief Measurer of the event to decide where checking what, respecting the above mentioned minimum controls established for the different levels.

Anyway, once the RM is approved, the Organizing Committee shall follow four steps:

1. Include the possibility of the RM process in the Notice of Race
2. Advise the National Secretaries and the competitors of the Championship Measurement Process
3. Publish the Measurement Instructions
4. Provide all measurers, directly or via the National Secretaries, with the necessary "void" stickers to certify that the RM specified controls have been made.

The templates of the necessary documents are showed in the next two pages.

The editable documents are also available on snipe.org, Rules page.

Measurers Role and Responsibilities at events

Boats are measured to establish compliance with the class rules. During events, a Technical Committee is appointed to perform the controls.

Racing Rules of Sailing (RRS) and Measurement

These rules lay down the role of the Technical Committees, their duties and responsibilities.

The rules read:

- 60.1 A Technical Committee may
- (a) protest a boat, but not
 - 60.4(b)(1) – from a request for redress
 - 60.4(b)(2) – from an invalid protest
 - 60.4(b)(3) – from a person with a conflict.
- However, under 60.4(c)(3) it may protest *if it has first conducted an inspection and decided* a boat or personal equipment does not comply with the class rules or rule 50;
- (b) request redress for a boat under 61.1(b); or
 - (c) report to the protest committee requesting action under rule 62.1 or 69.2(b).
- 78 Compliance with Class Rules, Certificates
- 78.1 While a boat is racing, her owner and any other person in charge shall ensure that the boat is maintained to comply with her class rules and that her measurement or rating certificate, if any, remains valid. In addition, the boat shall also comply at other times specified in the class rules, the notice of race or the sailing instructions. When a rule provides that the penalty for a breach of a class rule may be less than disqualification, the same penalty will apply to a breach of this rule.
- 78.2 When a rule requires a valid certificate to be produced or its existence verified before a boat races, and this cannot be done, the boat may race provided that the race committee receives a statement signed by the person in charge that a valid certificate exists. The boat shall produce the certificate or arrange for its existence to be verified by the Race Committee before the start of the last day of the event, or of the first series, whichever is earlier. The penalty for breaking this rule is disqualification without a hearing from all races of the event.
- 92 Technical Committee
- 92.1 A technical committee shall be a committee of at least one member and be appointed by the organizing authority or the race committee or as prescribed in the World Sailing Regulations.
- 92.2 The technical committee shall conduct equipment inspection and event measurement as directed by the organizing authority and as required by the *rules*.

It is important to note that the measurer has no authority to rescind a yacht's entry.

Measurers or Equipment Inspectors acting as part of the Technical Committee are entitled to protest a boat. The equipment inspector should know that unless the Notice of Race or Sailing Instructions permit alternative penalties, even a simple class rule breach will mean disqualification from one or even all races held during a day. A measurer should bear this in mind and may consider discussing the matter informally with the chairman of the protest committee, particularly if the deficiencies are in respect of many boats.

A Measurer / Equipment Inspector may discover issues on a boat that appear to breach the rules. Before the racing starts normally he will request the boat crew to correct any such situations. However after racing starts he has different responsibilities as a member of the event's Technical Committee. His role changes so that he initiates the process for the Technical Committee protests under rule 60.4. Measurement protests can also be initiated by another boat, rule 60.1, or by the Race Committee under rule 60.2, or by the protest committee, under rule 60.3. The rules do not give a Class Association or National Authority the right to protest on their own. Usually, when an Equipment Inspector files a protest as part of the Technical Committee he has to prepare the protest; therefore it is essential that he understands the relevant parts of the RRS as, in the event of a measurement protest, the procedures given in the RRS must be followed correctly. RRS 61 deals with the requirements so a protest can be considered valid. Typically the Chairman of the Technical Committee will represent the Technical Committee during a protest; therefore he needs to know how to behave and how to support his case in front of the Jury.

In case of doubts about the interpretation of the Class Rules, World Sailing Regulation 26.11 covers



Interpretation Procedures. For the Snipe Class, the Chairman of the Technical Committee is considered to be the ultimate qualified authority.

Application of Class Rules

A measurer must be completely conversant with the Class Rules in order to apply them correctly. To properly use Class Rules the measurer must understand and follow the general administration rules as well as the specific measurement rules.

Event Chief Measurer Duties

Timeline & Venue Requirements

- Begin contact with the SCIRA office to obtain contact information for the Chairman of the regatta. Establish the dates of measurement in coordination with the Organizing Committee, SCIRA office and SCIRA Representative for publication in the Notice of Race.
- Establish individual inspection stations for the following:

Snipe Equipment	Measurement Equipment Required	# Volunteers Required
Hull Weight MOI – if necessary	For weighing of the hull, a calibrated scale and area protected from the wind is essential. A similar area will be necessary if the MOI test needs to be performed.	Measurement: Weight: 2 MOI: 3
Rig: mast, boom, whiskerpole	A long table, suitable for the length of the mast is necessary	2
Appendages: rudder, daggerboard	A table large enough to measure the rudder & daggerboard	2
Sails	Protected area to measure sails: large enough for a Snipe mainsail to be unfolded	2-3
Administration	1 table for check-in/out	1-2

- Determine with Organizing Committee how measurement will be scheduled. Various methods include: first come, first served; by country; by bow number; by appointment.
- Ask Organizing Committee to include Measurement Verification Sheet (see Appendix) in each competitor registration packet.
- Create measurement staff to assist during measurement with assigned positions. Provide each measurer with the measurement rules for their equipment and go through measurement process with all at meeting held before measurement opens.

Equipment Details

Sail Inspection Table:

- large enough and at waist height to accommodate an unfurled mainsail. 90 to 100cm high.
- Head of main & jib at control point: dimension drawing at top corner of table and layout all the maximum dimensions radiating from the head point.
- Layout all the tack, head and clew corner dimensions just inside of the maximum length limits
- Battens: layout the 3 batten length maximums on the table.

Appendages:

- use a large table and mark limiting marks on table or use templates taped down.
- Set and screw for the rudder datum point on the template as well as a control pin low on the leading edge. Draw the max and min dimensions of the blade or use a mylar or hard template.
- Prepare a line to hang a scale for weighing rudder.
- Set two control pins to locate the daggerboard in the template. Screw down one pin at the bottom edge of the template and the other on the aft edge limit near the top of the daggerboard template, allowing quick and accurate positioning.

Rig:

- full table is needed to support the aft end of boom
- Make cutouts for shrouds attachments and spreader bracket so that the mast will lay flat on table.
- Mark all control marks using the butt of the mast as the control point.
- Prepare a line to attach a scale above the table roughly at the spreader bracket, to weigh and check the balance of the mast. (note: for pre-2001 boats, the control point will be the MDP). Use different color markers for sheer marks.
- Take boom measurements with a tape measure rather than laying out limiting marks on table.

Suggested Method:

1. roll boat into measurement area & check-in.
 - a. MDS checked against hull number
 - b. SCIRA sticker verified
 - c. Safety equipment checked
 - d. Bow numbers checked
 - e. if Remote Measurement is used, check the EIS and the stickers applied
2. Remove all equipment not allowed in boat during weigh-in
3. Sails taken to measurement table
4. Boat weighed, MOI'd if needed.
5. Appendages and rig taken to respective stations for measurement.
6. Attach measurement stickers and/or stamps (if being used) at each station if RM is not used.
7. Return to check-out station where Equipment Inspection Sheet is checked for completion & signed. Competitor takes EIS to registration.

Regatta Schedule

- Competitor receives Equipment Inspection Sheet (EIS) in registration packet
- Inspection appointments posted on official notice board
- Competitor completes inspection process & returns EIS to registration desk

Chief Measurer Responsibilities during an Event

- Organize measurement team
- Organize venue physical requirements
- Conduct Inspection process overseeing assistants
- Verify all EIS before racing begins and file for possible use during the event
- Be available for measurement questions throughout event (check with SCIRA Representative on this.)



The EIS and the Championship Equipment Regulations editable documents are available at <https://www.snipe.org/class-rules/> in the Race Management Tools section

SCIRA EQUIPMENT INSPECTION SHEET (EIS) EVENTS WITH ON SITE VERIFICATIONS ONLY

All items must be initialed and this sheet signed before your boat is approved for racing.

Event _____

Skipper _____ **Country** _____ **Bow** _____

Sail # _____

Crew _____

Hull # _____

Builder _____

Main-1st set

Jib-1st set

Mast _____

Sailmaker _____

Main-1st set

Jib-1st set

Sailmaker _____

	<i>✓ when completed</i>		<i>✓ when completed</i>
1. BOW NUMBERS		5. SPARS	
2. SAFETY EQUIPMENT		MAST	
2.1 8mm X 15m TOW LINE		5.1 MAST BANDS LOCATION	
2.2 PADDLE		5.2 MAST WEIGHT	
2.3 2 PERSONAL FLOTATION DEVICES		5.3 correctors weights (max 100g)	
3. HULL		5.4 SHROUDS, STAY, HALYARDS	
3.1 FULL HULL MEASUREMENT/MDS		5.5 MAIN LIMITING STOPPER	
3.2 SCIRA STICKER-CURRENT		BOOM	
3.3 HEAD STAY LOCATION		5.6 BOOM BAND LOCATION	
3.4 BOAT WEIGHT: 172.8 kgs		5.7 FOOT LIMITING STOPPER	
3.5 MOMENT OF INERTIA		5.8 WHISKER POLE LENGTH: 2642mm	
3.6 MAST HOLE min 1494mm		6. APPENDAGES	
4. SAILS		DAGGERBOARD	
4.1 MAIN#1 : DIMENSIONS & ROYALTIES		6.1 DIMENSIONS	
4.2 COUNTRY LETTERS & FULL NUMBERS		6.2 TAPERS	
4.3 BATTENS: T:457mm, C:686mm B:610mm		6.3 LIMITING BAND	
4.4 MAIN#2 : DIMENSIONS & ROYALTIES		6.4 RETAINING SYSTEM	
4.5 COUNTRY LETTERS & FULL NUMBERS		6.5 SAFETY LINE max 610mm	
4.6 BATTENS: T:457mm, C:686mm B:610mm		RUDDER	
4.7 JIB #1 : DIMENSIONS & ROYALTIES		6.6 DIMENSIONS	
4.8 CLOTH WEIGHT		6.7 LOCATION & PARALLEL TO HULL	
4.9 JIB #2 : DIMENSIONS & ROYALTIES		6.8 WEIGHT: 2.72 kgs	
4.10 CLOTH WEIGHT		6.9 corrector weights	

MEASUREMENT COMPLETED _____ date _____

 Measurer's signature

revised DECEMBER 2024

Equipment Regulations for events with Remote Measurement

The notation:

ER	means	Equipment Regulations
OC	means	Organizing Committee
ONB	means	Official Notice Board (either physical or virtual)
EIS	means	Equipment Inspection Sheet
MC	means	Measurement Certificate

1. GENERAL RULES

1.1. All boats (including hull, appendages, rig, sails and equipment) entering the event will be inspected in accordance with the present ER.

1.2 The responsibility to apply the Class Rules is in charge of the Chief Measurer of the event appointed by the Organizing Committee in accordance with the competent MNA and the SCIRA.

1.3 The Race Committee, if requested by the Chief Measurer, shall have the right to modify this ER and the changes will be posted on the Official Notice Board.

1.4 All competitors, in accordance with RRS 78, are responsible to keep their boats in compliance with the Class Rules.

1.5 All boats shall have a full MDS filed in the SCIRA database and a valid Measurement Certificate showing the amount and location of the corrector weights and the MOI value. The MC shall be presented to an Official Measurer. If there is any discrepancy between the MC and the boat a new weight and inertia test will be made.

1.6 In order to facilitate the measurements at the regatta the OC, in accordance with the Chief Measurer and the SCIRA, have sent to the National Secretaries and published on the official event site the instructions to check the boats in advance in their Countries. Pre-measured boats shall carry the Equipment Inspection Sheet marked where requested (@home controls).

1.7 If the @home controls are complete, competitors are allowed to sign up to measure their boat on site, according to the measurement schedule available on the Championship web site.

2. INSPECTION PROCEDURES AT THE CHAMPIONSHIP

2.1 Boats pre-measured and complying to ER 1.5, will proceed to register at the Race Office where the time to weight the boat and measure/stamp the sails will be confirmed (under ER 1.7) or assigned.

2.2 Boats not pre-measured and/or not complying to ER 1.5, will pick up a blank EIS at the Race Office and the time for the measurement will be confirmed (under ER 1.7) or assigned.

2.3 At the scheduled time, competitors shall be in the measurement area with the EIS and a copy of their valid Measurement Certificate with the proper equipment to be checked/stamped in dry, salt free and clean condition.

2.4 Once the process is completed and the EIS is signed by the Official Measurer, competitors shall present the EIS to the Race Office to complete their entry.

2.6 Unless authorized by an Official Measurer, neither corrections nor modifications are allowed to the boat, equipment or sails inside the measurement area.

3. BOATS AND STAMPED EQUIPMENT

3.1 Once boat, rig, appendages, sails and equipment have passed the inspection control and have been stamped/marked, the boat can move to the parking area assigned by the OC.

3.2 Once a boat has passed the inspection, no modifications or repairs can be made unless authorized by the Race Committee. If the permission is given, an Official Measurer shall approve the repairs.

3.4 Any request to change failed equipment during the races shall be submitted to the Race Committee according to the Notice of Race or the Sailing Instructions.

4. AFTER RACING CONTROLS

4.1 Any boat, rig, appendages, sails and equipment can be inspected at any time during the championship, at sea or ashore, and any irregularity will be reported to the Race Committee.

4.2 After each race, competitors may be informed by the measurer or notified on the ONB that they have been selected for a measurement inspection ashore. Once it has been notified, the boat shall proceed to the measurement area. Boats will be inspected as soon as possible.

4.3 At least one crew member shall be present during the whole period of the boat inspection. If the measurer is not satisfied of the inspection, the boat can be retained to be weighed in dry conditions later.

4.4 A rib identified by a white flag with a black "M" with a measurer on board will be allocated close to the the finishing line. All boats, after finishing any race, shall sail close to this boat which will hail the sail number of the boats to be inspected.

4.5 Boats which will be inspected ashore, will be accompanied by the measurer to the measuring area, where they will be weighed and verified.

4.6 Any failure to attend the verifying process on the water or ashore, will be ground for a protest by an Official Measurer.

5. OFFICIAL NOTICES

5.1 A white flag with a black "M" over the letter "L" of the ICS displayed in the Official signaling pole means: "A measurement notice to participants has been posted on the ONB".



CHAMPIONSHIP EQUIPMENT REGULATION

Date:

to:

National Secretaries

participants in the <insert event> Championship

The <insert event> Organizing Committee foresees a large participation in the event which will take place in <insert location>.

Under agreement of the <insert appropriate Snipe authority> and the Chief Measurer, to facilitate the measurement process the following procedures are strongly recommended

1. All boats entering the <insert event> are requested to be measured in their Countries by an appointed measurer.
2. The Organizing Committee will post on the official web page (<insert url>) the Equipment Inspection Sheet (EIS) to be filled in and send to the National Secretaries the stickers to mark the measured equipment (rig, appendages, hull, etc.)
3. Each National Secretary will send a list of the appointed measurers to the Organizing Committee before the beginning of the event. If no measurer is available in the home Country, all associated boats will be controlled on site according to the NoR.
4. At the Championship, to proceed with the measurement, competitors shall present the EIS filled in the appropriate spaces (@home controls) together with their Measurement Certificate (MC) to the Chief Measurer
5. Those boats with both EIS and MC shall be checked according to the EIS and the sails verified (sails must be presented already measured and stamped by a SCIRA or Sailing Federation appointed measurer; **please remember that according to RRS Appendix G no digital-like numbers are accepted**). All other boats will be measured in full according to the NoR.

The Technical Committee



SCIRA EQUIPMENT INSPECTION SHEET (EIS) EVENTS WITH REMOTE MEASUREMENTS

All items must be initialed and this sheet signed before your boat is approved for racing.

Event: _____.

Skipper _____ Bow _____

Country _____

Sail # _____

Crew _____

Hull # _____

Builder _____

	<i>✓ when completed</i>		<i>✓ when completed</i>
@HOME CONTROLS		ON SITE CONTROLS	
1. CHAMPIONSHIP SPECIFIC CONTROLS		2. ROC 3.7	
1.1 HEAD STAY LOCATION		2.1 8mm X 15m TOW LINE	
1.2 MAST HOLE DIST.: 1494mm		2.2 PADDLE	
1.3 DAGGERBOARD BAND		2.3 2 PERSONAL FLOTATION DEVICES	
1.4 DAGGERBOARD STOPPERS		2.4 SCIRA STICKER - CURRENT	
1.5 RUDDER WEIGHT: 2.72 kgs		3. DAGGERBOARD	
1.6 RUDDER corrector weights		3.1 DAGGERBOARD RETAINING SYSTEM	
1.7 MAST BANDS & STOPPER		3.2 DAGGERBOARD SAFETY LINE max 610mm	
1.8 BOOM BAND & STOPPER		4. RUDDER	
1.9 WHISKERPOLE LENGTH		4.1 RUDDER SECURITY SYSTEM	
		4.2 CUSTOM RUDDERS SHAPE	
		5. MAST STEP	
		6. BOAT WEIGHT	
7. SAILS			
MAIN#1: MANUFACTURER		MAIN#2: MANUFACTURER	
7.1 DIMENSIONS & ROYALTIES		7.1 DIMENSIONS & ROYALTIES	
7.2 COUNTRY LETTERS & FULL NUMBERS		7.2 COUNTRY LETTERS & FULL NUMBERS	
7.3 BATTENS: T:457mm, C:686mm B:610mm		7.3 BATTENS: T:457mm, C:686mm B:610mm	
JIB #1: MANUFACTURER		JIB #2: MANUFACTURER	
7.4 DIMENSIONS & ROYALTIES		7.4 DIMENSIONS & ROYALTIES	
7.5 CLOTH WEIGHT (check sailmaker's stamp)		7.5 CLOTH WEIGHT (check sailmaker's stamp)	

@HOME
MEASURER SIGNATURE _____ *Measurer's signature* _____ *date*

ON SITE
VERIFICATION COMPLETED _____ *Measurer's signature* _____ *date*

updated DECEMBER 2024





Snipe Class International Racing Association

